









- |   |   |   |                            |   |  |   |                        |   |                                     |
|---|---|---|----------------------------|---|--|---|------------------------|---|-------------------------------------|
|  | Airbag  |  | Generatore di gas          |  | Pretensionatore delle cinture di sicurezza |  | Scheda elettronica SRS |  | Sistema attivo di protezione pedoni |
|  | Ammortizzatore pneumatico / molla precaricata |  | Batteria a basso voltaggio |  | Diesel serbatoio del carburante            |   |                        |   |                                     |

Nota: Ulteriori informazioni sono disponibili nelle nostre linee guida per il soccorso [linee guida per il soccorso](#)



1. Identificazione / riconoscimento

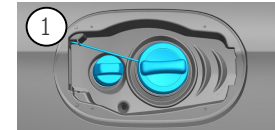

2  
**CLA 180d**

2. Immobilizzazione / stabilizzazione / sollevamento

Freno di parcheggio

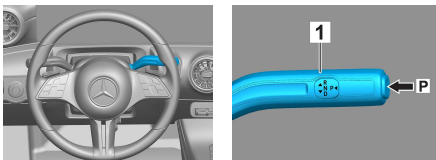

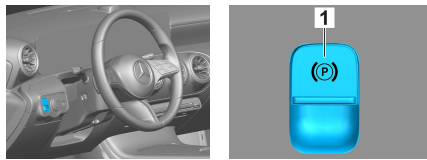

Freno di stazionamento

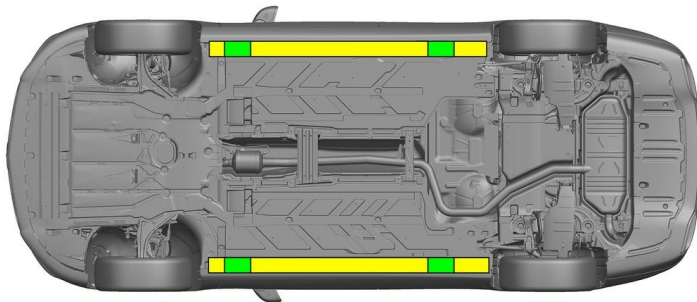

Premere il pulsante P sulla leva di selezione (1). Il freno di stazionamento elettrico (1) viene attivato automaticamente.



 Adeguati punti di sollevamento  
 Adeguati punti di stabilizzazione sul lato

 Evitare un'ulteriore deformazione della pedana e del sottoscocca durante il salvataggio (ad es. sollevamento con equipaggiamento idraulico).

3. Disattivazione dei pericoli diretti / Regolamenti di Sicurezza

Disinserire l'accensione:

- 1. Premere il tasto START-STOP senza azionare il freno di esercizio.
- 2. Tenere la chiave elettronica del veicolo a distanza di almeno 5 m.

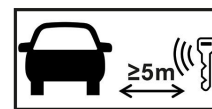

 L'assenza di rumori dal motore non significa che il veicolo sia spento.

 Un riavvio è possibile solo fino alla messa fuori servizio del veicolo.



Scollegare la batteria a 12 V

- 1. Rimuovere il coperchio della batteria a 12 Volt.
- 2. Scollegare il cavo negativo della batteria a 12 Volt nel raccordo a vite e metterlo in sicurezza contro un involontario contatto.

 I sistemi di sicurezza passivi (airbag e pretensionatori delle cinture di sicurezza) vengono disattivati.



### 4. Accesso agli occupanti

Nell'ambito della liberazione degli occupanti si deve tenere conto dei componenti dei sistemi di ritenuta (in particolare degli elementi pirotecnic) conformemente alle indicazioni fornite a pagina 1.



Regolazione del volante

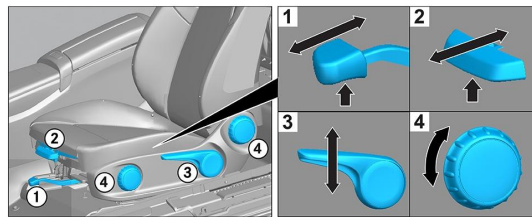



Regolazione (meccanica) del sedile

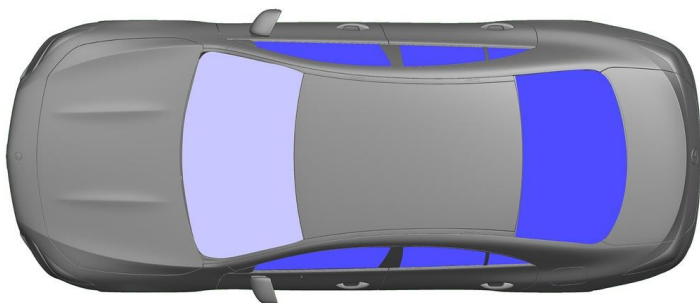

Regolazione (elettrica) del sedile



-  VSG: Verbundsicherheitsglas, vetro stratificato di sicurezza
-  ESG: vetro di sicurezza monostrato

### 5. Immagazzinamento energia / liquidi / gas / solidi



### 6. In caso d'incendio



Per estinguere l'incendio di un veicolo utilizzare grandi quantità di acqua (H<sub>2</sub>O).

### 7. In caso di immersione

Non sussiste il pericolo di tensione sulla carrozzeria. Dopo il recupero del veicolo:

1. Fare defluire l'acqua dall'abitacolo.
2. Avviare la disattivazione della rete di bordo a 12/48 V (vedere il capitolo 3).

### 8. Traino / trasporto / stazionamento

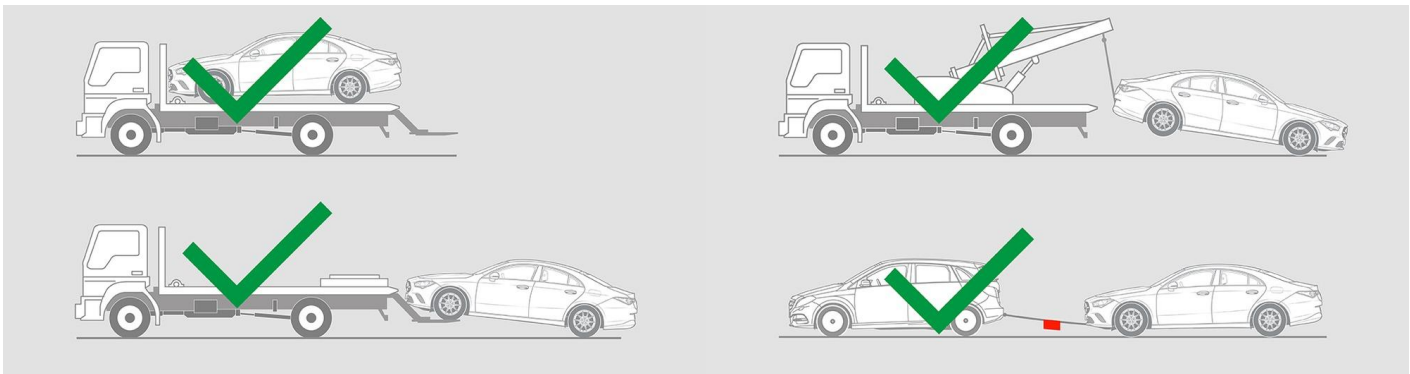



## 9. Informazioni aggiuntive importanti

Ulteriori informazioni sono riportate nelle [Linee guida per i servizi di traino Autovetture](#).

## 10. Spiegazione dei pittogrammi utilizzati

	Veicolo con carburante del gruppo liquido 1		Attenzione pericolo generico		Infiammabile		Pericoloso per la salute umana
	Corrosivi		Tossicità acuta		Utilizzare l'acqua per spegnere l'incendio		Utilizzare schiuma a secco per spegnere l'incendio
	Utilizzare schiuma bagnata per spegnere l'incendio		Cofano		Rimozione chiave intelligente		