

- |   |   |   |  |  |
|---|---|---|--|--|
|  Airbag                          |  Gasgenerator        |  Forspænder til sikkerhedssele |  SRS kontrolenhed |  Aktivt fodgængerbeskyttelsessystem |
|  Gastryksdæmper/forspændt fjeder |  Lavspændingsbatteri |  Benzinae brændstoftank        |  |  |

Bemærkning: For yderligere oplysninger henvises til vores [redningsvejledning](#).

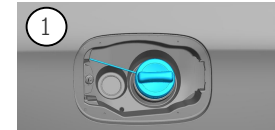

1. Identifikation / genkendelse



2  
**CLA 200**

2. Immobilisering / Stablisering / Løft

Parkeringsbremse

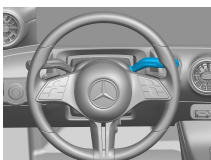



Håndbremse

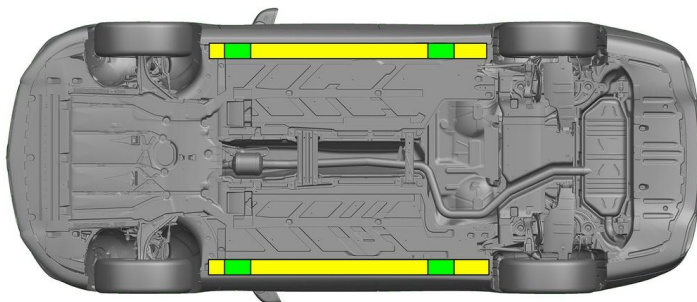

Tryk på kontakten P på gearvælgeren (1). Parke-  
ringsbremsen aktiveres automatisk.

Elektrisk håndbremse (1)



-  Egnede løftepunkter
-  Egnede stabiliseringspunkter på siden

 Yderligere deformering af karme og undervogn under bjærgningen (f.eks. ved afstivning med hydraulisk udstyr) skal undgås.

3. Deaktivering særlige farer / sikkerhedsforskrifter

Slå tændingen fra:

1. Tryk på START-STOP-knappen uden at aktivere driftsbremsen.
2. Hold den elektroniske køretøjsnøgle i en afstand på mindst 5 m.

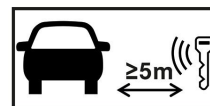

 Fraværet af motorlyde betyder ikke, at køretøjet er slukket.

 En genstart er mulig, indtil køretøjet tages ud af drift.



Afbryd 12/48 V-batteriet

1. Fjern dækslet til 12/48-voltsbatterierne.
2. Løsn minuskablet på 12/48-voltsbatteriet ved skrueforbindelsen, og sikr det mod utilsigtet kontakt.

 De passive sikkerhedssystemer (airbags og forspændere til sikkerhedssele) deaktiveres.



### 4. Adgangveje til tilskadekommande

Ved frigørelse af personerne i bilen skal der tages hensyn til komponenterne i sikkerhedssystemerne (især pyrotekniske elementer) i overensstemmelse med angivelserne på side 1.



Ratindstilling

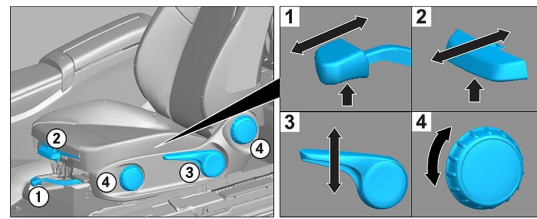



Sædeindstilling (mekanisk)



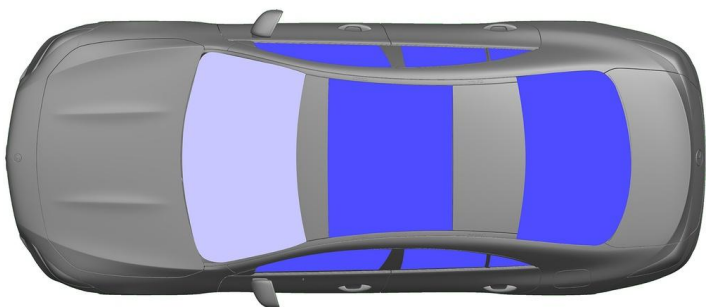











Sædeindstilling (elektrisk)



 VSG: lamineret sikkerhedsglas

 ESG: hærdet glas

### 5. Oplagret energi / væsker / gasser / faste stoffer

	    	12/48V
	 	43
	  	590 ± 10g

### 6. I tilfælde af brand



Brug store mængder vand (H<sub>2</sub>O), når en køretøjsbrand skal slukkes.

### 7. I vand

Der er ingen fare ved, at der er spænding på karrosseriet. Efter bjærgning af køretøjet:

1. Lad vandet løbe ud af kabinen.
2. Påbegynd deaktivering af 12-/48-voltsledningsnettet (se kapitel 3).



### 8. Bugsering / transport / opbevaring

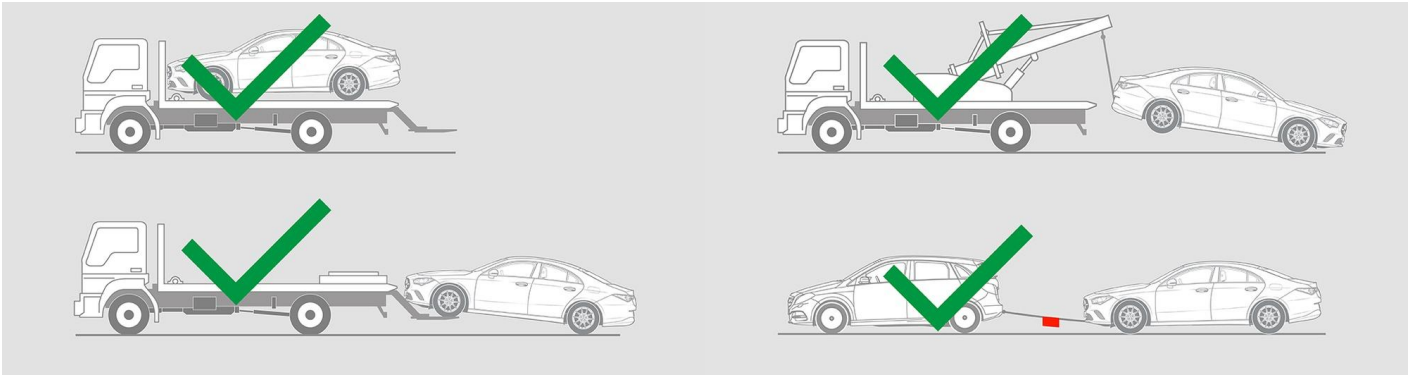

### 9. Vigtige ekstra oplysninger

Yderligere oplysninger findes i [Vejledning for bjærgningsfirmaer, personvogne](#).

### 10. Piktogram information

-  Køretøj på brændstof i klasse 2
-  Generelt advarsskilt
-  Brandfarligt
-  Farligt for menneskers sundhed
-  Ætsende
-  Akut toksicitet
-  Eksplosiv
-  Brug vand til at slukke ilden
-  Brug tørt skum til at slukke ilden
-  Brug vådt skum til at slukke ilden
-  Fjern smart nøgle
-  Klima anlæg
-  Advarsel; lav temperatur