

-  Zračni meh
-  Plinski generator
-  Zateznik varnostnega pasu
-  Krmilna enota za pomožni omejevalni sistem SRS
-  Plinski blažilnik/prednapeta vzmet
-  Nizkovoltni akumulator
-  Dizel rezervoar za gorivo
-  Baterijski sklop, visokonapetostni
-  Visokonapetostni električni kabel
-  Komponenta za visoko napetost
-  Pretrganje kablov
-  Nizkonapetostna naprava, ki izklopi visoko napetost

Napotek: Za več informacij si oglejte naš [reševalni vodnik](#).

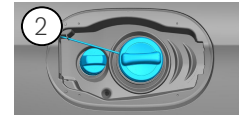

### 1. Identifikacija / prepoznavanje

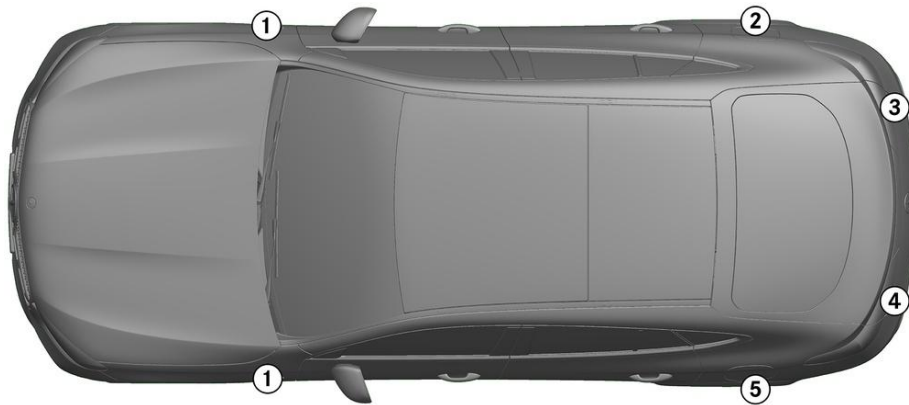

### 2. Imobilizacija / stabilizacija / dvig

#### Ročna zavora

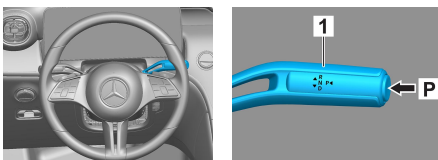

#### Parkirna zavora

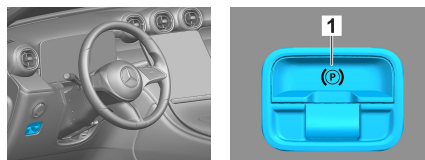

Pritisnite stikalo P na izbirni ročici (1). Ročna zavora se aktivira samodejno.

Električna parkirna zavora (1)

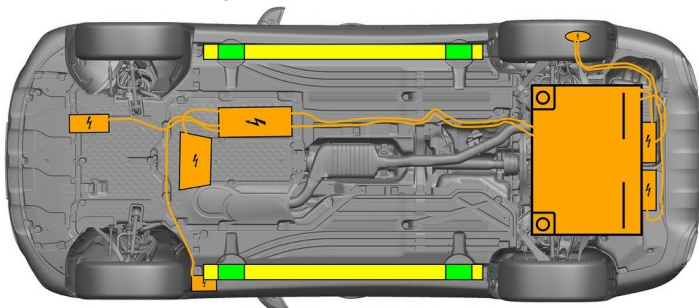

- Ustrezne dvizne točke
- Ustrezne stabilizacijske točke na strani
- Visokonapetostni akumulator



Preprečiti je treba dodatne deformacije pragov in podvozja med reševanjem (npr. s podporo s hidravlično opremo).

### 3. Onemogočanje neposrednih nevarnosti / varnostni predpisi

#### Izklop vžiga:

1. Pritisnite tipko START-STOP brez aktiviranja delovne zavor.
2. Elektronski ključ vozila hranite na razdalji najmanj 5 m.

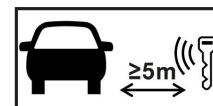

Odsotnost hrupa motorja ne pomeni, da je vozilo izklopljeno.



Ponovni zagon je možen, dokler vozilo ne preneha delovati.

#### Deaktiviranje visokonapetostnega sistema



V primeru nesreče, v kateri se sprožijo zračne blazine in zategovalniki varnostnega pasu, se visokonapetostni sistem samodejno izklopi.





V vseh drugih primerih je treba visokonapetostni sistem deaktivirati na naslednji način:



### Možnost 1: Visokonapetostna odklopna naprava

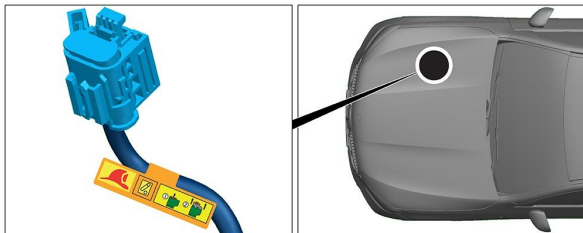

Visokonapetostna odklopna naprava se nahaja v prostoru za motor na sovoznikovi strani.

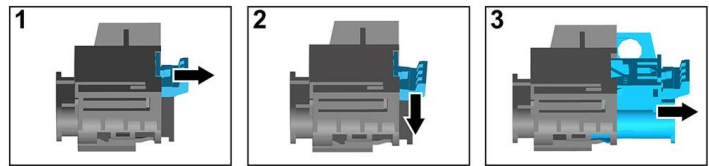

- (1) Povlecite deblokado
- (2) Deblokado pritisnite navzdol
- (3) Izvlecite stikalo



### Možnost 2: Alternativna visokonapetostna odklopna naprava

Alternativna visokonapetostna odklopna naprava se nahaja pod pokrovom ohišja z varovalkami na armaturni plošči na voznikovi strani. Označena je s tablico z napotkom.

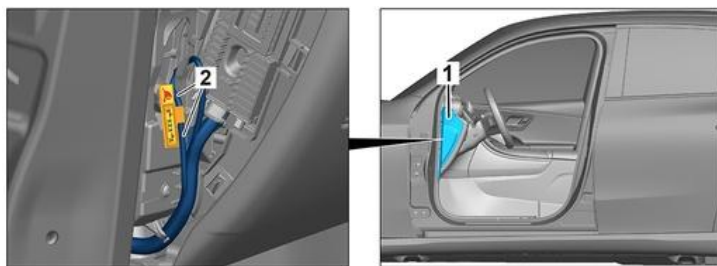

Odstranite pokrov (1). Prerežite vodnik na označenem mestu (2).



Da zagotovite, da v visokonapetostnem omrežju ni preostale napetosti, po izklopu počakajte približno 20 sekund.



Pasivne varnostne sisteme, kot so zračne blazine in zategovalnik varnostnega pasu, še naprej napaja 12-voltni električni sistem vozila.



### Odklop 12-V akumulatorja



1. Odstranite pokrov 12-V akumulatorja v prostoru za motor.
2. Odvijte negativni kabel 12-V akumulatorja na vijahnem priključku in ga zavarujte pred nenamernim stikom.



Pasivni varnostni sistemi (zračne blazine in zategovalniki varnostnega pasu) se deaktivirajo.



## 4. Dostop do potnikov

Pri reševanju potnikov upoštevajte komponente zadrževalnih sistemov (posebno pirotehnične elemente) v skladu s podatki na 1. strani.

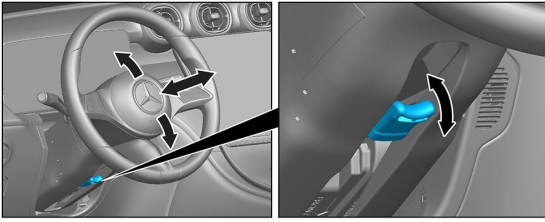

Nastavitev volana

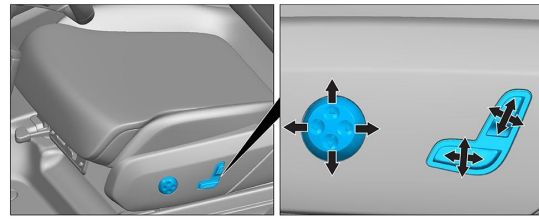

Nastavitev sedeža (električna)

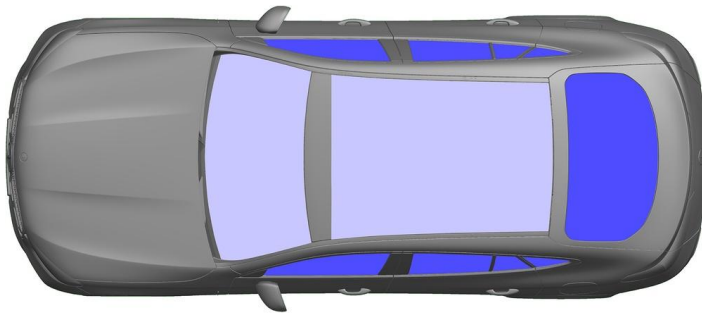

VSG: laminirano varnostno steklo  
ESG: enoslojno varnostno steklo

## 5. Shranjena energija / tekočine / plini / trdne snovi



Vsi visokonapetostni vodniki so opremljeni z oranžno izolacijo.

## 6. V primeru požara



Za gašenje požara v vozilu uporabite velike količine vode (H<sub>2</sub>O).  
Za hlajenje litij-ionskega akumulatorja uporabite velike količine vode (H<sub>2</sub>O).



Opozorilo: Ponoven vžig akumulatorja



Če hladilno sredstvo izstopa iz visokonapetostnega akumulatorja, lahko zaradi toplotne preobremenitve postane nestabilna. Temperaturo akumulatorja preverite z IR termovizijsko kamero.



## 7. V primeru potopitve

Ni nevarnosti, da bi na karoseriji prišlo do napetosti.

Po reševanju vozila:

1. Pustite, da voda iz notranjosti odteče.
2. Zaženite deaktivacijo visokonapetostnega sistema (glejte poglavje 3).



## 8. Vleka / prevoz / shranjevanje

Vozilo prevažajte na vlečnem vozilu ali avtotransporterju samo z obema osema.

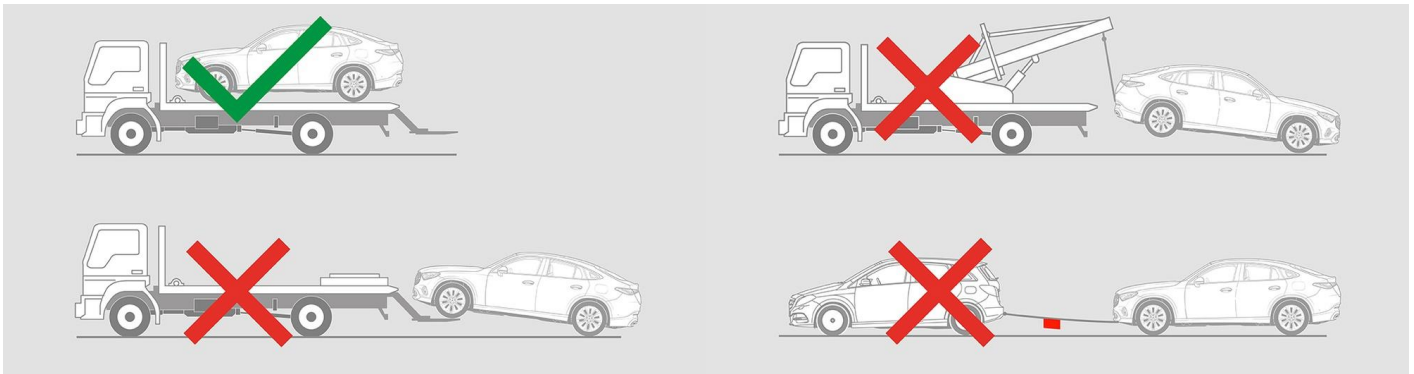

Shranite ga na varni razdalji od drugih vozil.



Opozorilo: Ponoven vžig akumulatorja



## 9. Pomembne dodatne informacije

Nadaljnje informacije najdete v [Vodniku vlečne službe za osebna vozila](#).

## 10. Razlaga uporabljenih piktogramov



Hibridno električno vozilo na tekoče gorivo skupine 1



Splošen opozorilni znak



Opozorilo, elektrika



Vnetljivo



Nevarnost za zdravje ljudi



Jedke snovi



Akutna strupenost



Za gašenje požara uporabite vodo



Uporaba termične infrardeče kamere



Pokrov



Odstranite pametni ključ