











- | | | | | | | | | | |
|---|---|---|------------------------------------|---|---------------------------|---|--|---|----------------------------------|
|  | Zračni meh |  | Plinski generator |  | Zateznik varnostnega pasu |  | Krmilna enota za pomožni omejevalni sistem SRS |  | Aktivni sistem za zaščito pešcev |
|  | Samodejni sistem za zaščito pri prevračanju |  | Plinski blažilnik/prednapeta vzmet |  | Strukturna ojačitev |  | Nizkovoltni akumulator |  | Bencin rezervoar za gorivo |

Napotek: Za več informacij si oglejte naš [reševalni vodnik](#).



1. Identifikacija / prepoznavanje

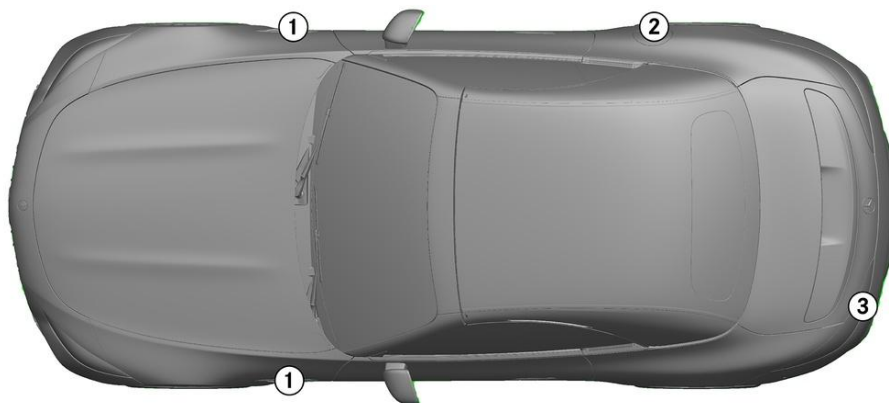

①

V8 BITURBO

②

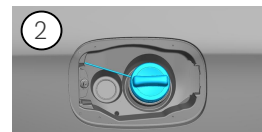

③

AMG

2. Imobilizacija / stabilizacija / dvig

Ročna zavora

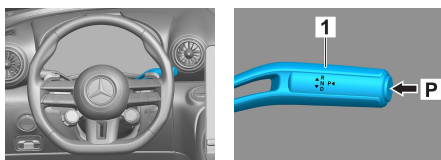

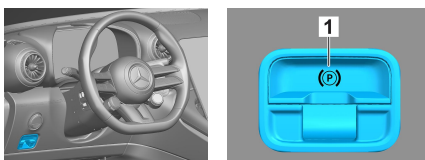

Parkirna zavora

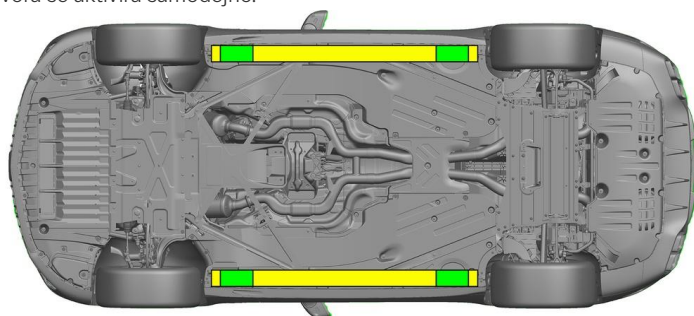

Pritisnite stikalo P na izbirni ročici (1). Ročna zavora se aktivira samodejno.

Električna parkirna zavora (1)



 Ustrezne dvizne točke

 Ustrezne stabilizacijske točke na strani



Preprečiti je treba dodatne deformacije pragov in podvozja med reševanjem (npr. s podporo s hidravlično opremo).

3. Onemogočanje neposrednih nevarnosti / varnostni predpisi

Izklop vžiga:

1. Pritisnite tipko START-STOP brez aktiviranja delovne zavore.
2. Elektronski ključ vozila hranite na razdalji najmanj 5 m.



Odsotnost hrupa motorja ne pomeni, da je vozilo izklopljeno.



Ponovni zagon je možen, dokler vozilo ne preneha delovati.



Odklop 12-V/48-V akumulatorja

1. Odstranite pokrov 12/48-V akumulatorja v prostoru za motor.
2. Odvijte negativni kabel 12/48-V akumulatorja na vijačnem priključku in ga zavarujte pred nenamernim stikom.





Odklop 12/48-V akumulatorja



1. Odstranite pokrov 12/48-V akumulatorja v prtljažniku.
2. Odvijte negativni kabel 12/48-V akumulatorja na vijačnem priključku in ga zavarujte pred nenamernim stikom.



Pasivni varnostni sistemi (zračne blazine in zategovalniki varnostnega pasu) se deaktivirajo.

4. Dostop do potnikov

Pri osvobajanju potnikov je treba upoštevati predele karoserije iz visoko trdnega jekla in sestavne dele zadrževalnih sistemov (zlasti pirotehnične elemente) v skladu z navedbami na strani 1.

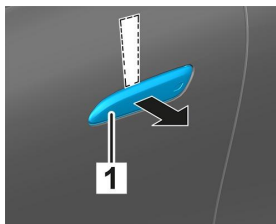

Ploščat, nekovinski predmet potisnite od zgoraj za umaknjeno kljuko vrat (1) in ga dvignite rahlo navzven.

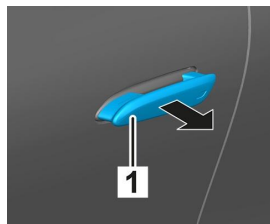

Od spodaj sežite za kljuko vrat (1) in povlecite navzven, dokler ne začutite upora, in držite.

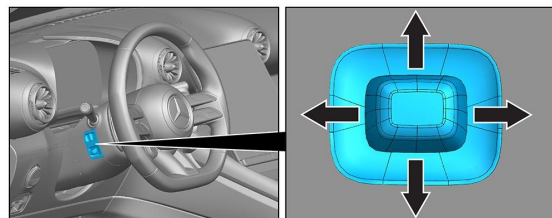

Nastavitev volana

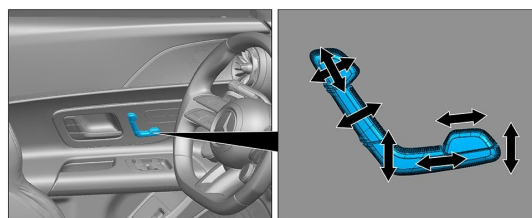

Nastavitev sedeža (električna)

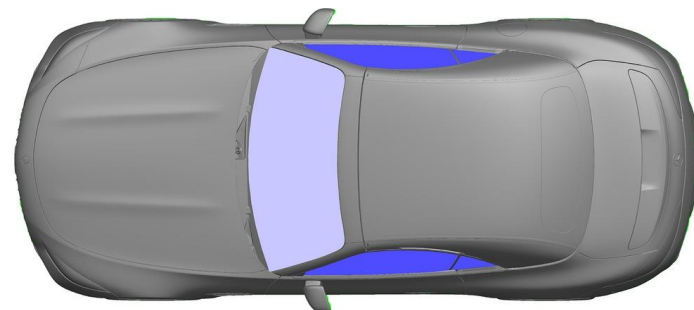

- VSG: laminirano varnostno steklo
- ESG: enoslojno varnostno steklo

5. Shranjena energija / tekočine / plini / trdne snovi



6. V primeru požara



Za gašenje požara v vozilu uporabite velike količine vode (H₂O).

7. V primeru potopitve

Ni nevarnosti, da bi na karoseriji prišlo do napetosti. Po reševanju vozila:

1. Pustite, da voda iz notranjosti odteče.
2. Zaženite deaktivacijo 12/48-V električnega sistema vozila (glejte poglavje 3).



8. Vleka / prevoz / shranjevanje

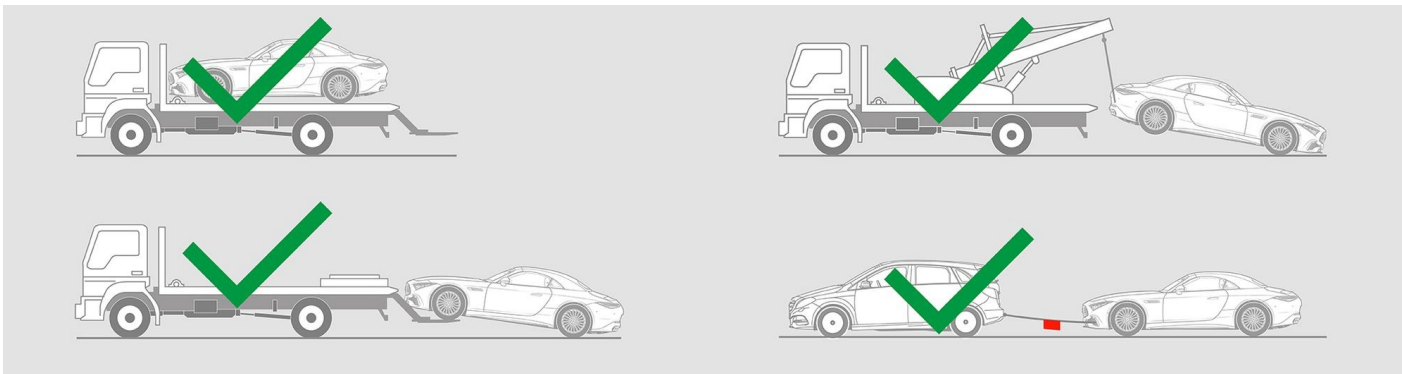

9. Pomembne dodatne informacije

Nadaljnje informacije najdete v [Vodniku vlečne službe za osebna vozila](#).

10. Razlaga uporabljenih piktogramov

	Vozilo na tekoče gorivo skupine 2		Splošen opozorilni znak		Vnetljivo		Nevarnost za zdravje ljudi
	Jedke snovi		Akutna strupenost		Za gašenje požara uporabite vodo		Za gašenje požara uporabite suho peno
	Za gašenje požara uporabite vlažno peno		Pokrov		Prtljažnik		Odstranite pametni ključ