

- | | | | | | | | | | |
|---|---------------------------------|---|---------------------|---|---|---|---------------------------|---|------------------------------------|
|  | Airbag |  | Gasgenerator |  | Forspænder til sikkerhedssele |  | SRS kontrolenhed |  | Aktivt fodgængerbeskyttelsessystem |
|  | Gastryksdæmper/forspændt fjeder |  | Lavspændingsbatteri |  | Diesel brændstoftank |  | Batteripakke, højspænding |  | Højspændingskabel |
|  | Højspændingskomponent |  | Kabelskæring |  | Lavspændingsenhed, der afbryder højspænding | | | | |

Bemærkning: For yderligere oplysninger henvises til vores [redningsvejledning](#).

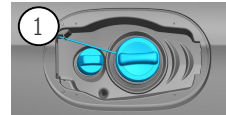

1. Identifikation / genkendelse



3

4

C 300de 4MATIC

2. Immobilisering / Stabilisering / Løft

Parkeringsbremse

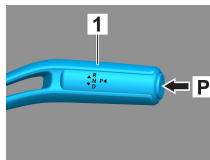

Håndbremse

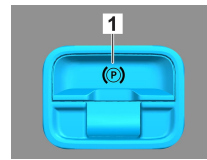
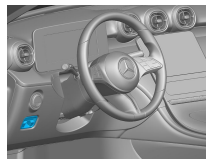

Tryk på kontakten P på gearvælgeren (1). Parkeringsbremsen aktiveres automatisk.

Elektrisk håndbremse (1)

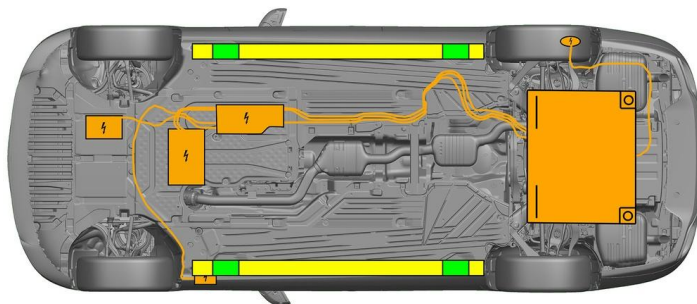

Egnede løftepunkter



Egnede stabiliseringspunkter på siden



Højvoltsbatteri



Yderligere deformering af karme og undervogn under bjærgningen (f.eks. ved afstivning med hydraulisk udstyr) skal undgås.

3. Deaktivering særlige farer / sikkerhedsforskrifter

Slå tændingen fra:

1. Tryk på START-STOP-knappen uden at aktivere driftsbremsen.
2. Hold den elektroniske køretøjsnøgle i en afstand på mindst 5 m.

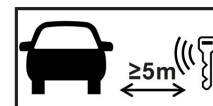

Fraværet af motorlyde betyder ikke, at køretøjet er slukket.



En genstart er mulig, indtil køretøjet tages ud af drift.

Deaktivering af højvoltssystemet



I tilfælde af ulykker, hvor airbags og forspændere til sikkerhedssele udløses, slås højvoltssystemet automatisk fra.





I alle andre tilfælde skal højvoltage systemet deaktiveres på følgende måde:

Mulighed 1: Højvoltsafbryder

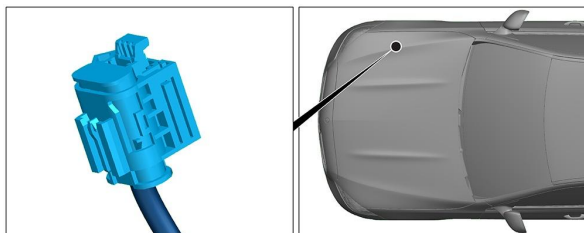

Højvoltsafbryderen sidder i motorrummet i passagersiden.



- (1) Træk i grebet til oplåsning
- (2) Tryk grebet til oplåsning nedad
- (3) Træk kontakten ud



Mulighed 2: Alternativ højvoltsafbryder

Den alternative højvoltsafbryder sidder under dækslet til sikringsboksen i cockpittet i førersiden. Den er afmærket.

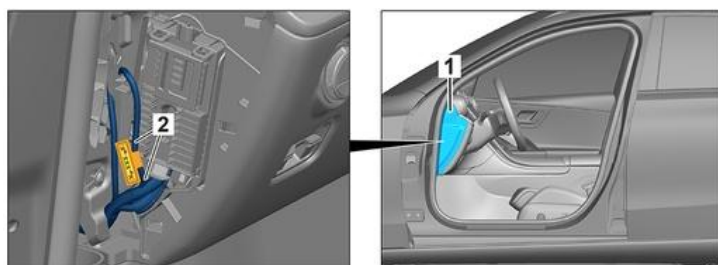

Fjern dækslet (1). Skær ledningen over ved det markerede punkt (2).



For at sikre, at der ikke er restspænding i højspændingsnettet, skal du vente cirka 20 sekunder efter afbrydelsen.



De passive sikkerhedssystemer såsom airbags og forspændere til sikkerhedssele forsynes fortsat med strøm fra 12-voltsledningsnettet.



Afbryd 12 V-/48-V-batteriet



1. Fjern dækslet til 12-/48-voltsbatterierne i motorrummet.
2. Løsn minuskablet på 12-/48-voltsbatteriet ved skrueforbindelsen, og sikr det mod utilsigtet kontakt.



De passive sikkerhedssystemer (airbags og forspændere til sikkerhedssele) deaktiveres.



4. Adgangveje til tilskadekommande

Ved frigørelse af personerne i bilen skal der tages hensyn til komponenterne i sikkerhedssystemerne (især pyrotekniske elementer) i overensstemmelse med angivelserne på side 1.

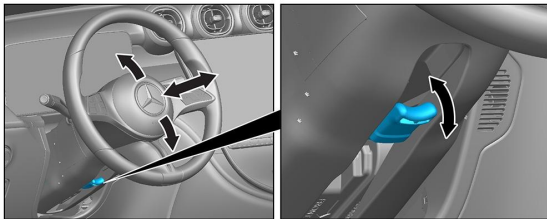

Ratindstilling

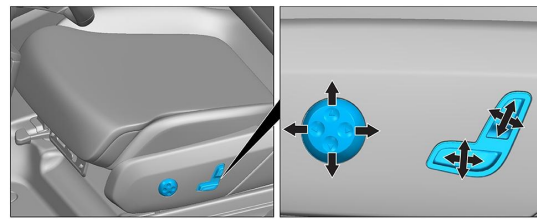

Sædeindstilling (elektrisk)

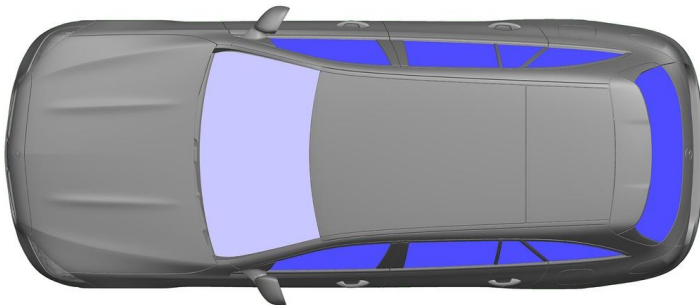

- VSG: lamineret sikkerhedsglas
- ESG: hærdet glas

5. Oplagret energi / væsker / gasser / faste stoffer



Alle højvoltsledninger er forsynet med en orangefarvet isolering.

6. I tilfælde af brand

Brug store mængder vand (H_2O), når en køretøjsbrand skal slukkes.
Brug store mængder vand (H_2O) til at afkøle li-ion-batteriet.

Advarsel: Genantændelse af batteriet



Hvis kølemiddel lækker fra højvoltsbatteriet, kan det blive ustabil på grund af termisk overbelastning. Kontrollér batteriets temperatur med et IR-varmefølsomt kamera.



7. I vand

Der er ingen fare ved, at der er spænding på karrosseriet.

Efter bjærgning af køretøjet:

- Lad vandet løbe ud af kabinen.
- Påbegynd deaktivering af højvoltage systemet (se kapitel 3).



8. Bugsering / transport / opbevaring

Transportér kun køretøjet med begge hjulsæt på et bugseringskøretøj eller en autotransporter.

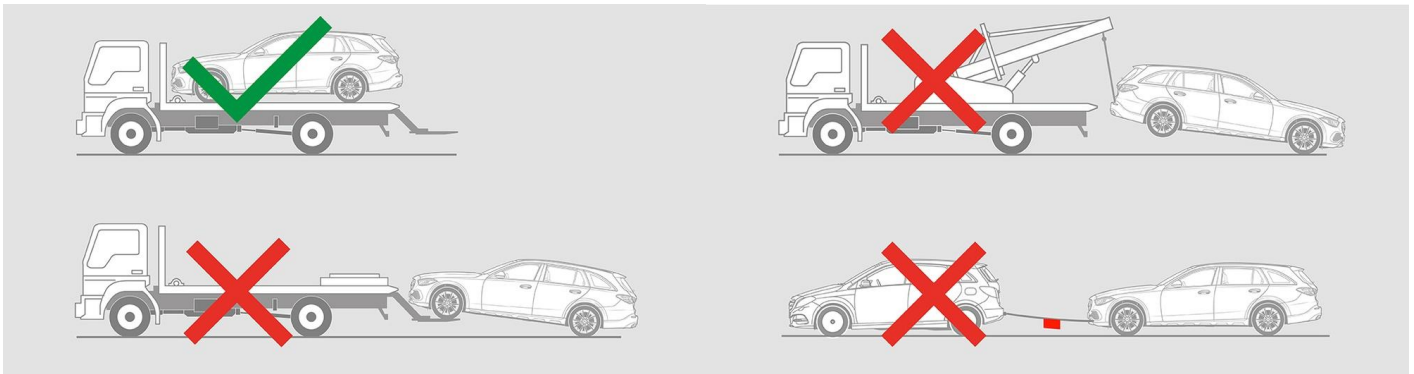

Opbevaring i sikker afstand af andre køretøjer.



Advarsel: Genantændelse af batteriet



9. Vigtige ekstra oplysninger

Yderligere oplysninger findes i [Vejledning for bjærgningsfirmaer, personvogne](#).

10. Piktogram information



Hybrid elektrisk køretøj på brændstof i klasse 1



Generelt advarselsskilt



Advarsel, elektricitet



Brandfarligt



Farligt for menneskers sundhed



Ætsende



Akut toksicitet



Brug vand til at slukke ilden



Brug termisk infrarødt kamera



Motorhjelm



Fjern smart nøgle