

- | | | | | | | | | | |
|---|---------------------------------|---|---------------------|---|---|---|---------------------------|---|------------------------------------|
|  | Airbag |  | Gasgenerator |  | Forspænder til sikkerhedssele |  | SRS kontrolenhed |  | Aktivt fodgængerbeskyttelsessystem |
|  | Gastryksdæmper/forspændt fjeder |  | Lavspændingsbatteri |  | Benzinae brændstoftank |  | Batteripakke, højspænding |  | Højspændingskabel |
|  | Højspændingskomponent |  | Kabelskæring |  | Lavspændingsenhed, der afbryder højspænding | | | | |

Bemærkning: For yderligere oplysninger henvises til vores [redningsvejledning](#).

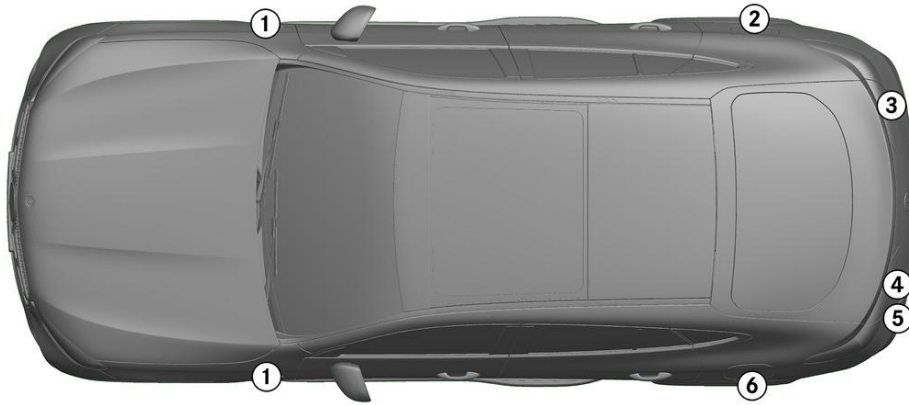

1. Identifikation / genkendelse



2. Immobilisering / Stabilisering / Løft

Parkeringsbremse

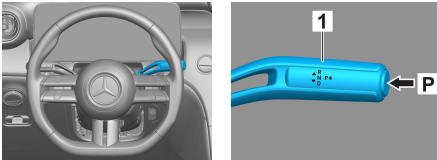

Håndbremse

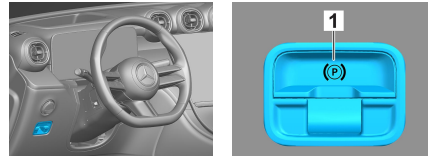

Tryk på kontakten P på gearvælgeren (1). Parke-
ringsbremsen aktiveres automatisk.

Elektrisk håndbremse (1)

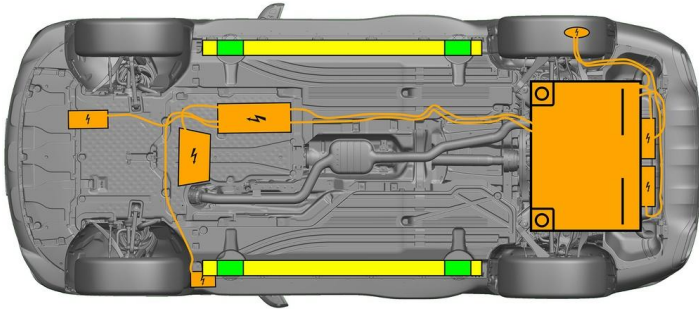

- Egnede løftepunkter
- Egnede stabiliseringspunkter på siden
- Højvoltsbatteri



Yderligere deformering af karmer og undervogn under bjærgningen (f.eks. ved afstivning med hydraulisk udstyr) skal undgås.

3. Deaktivering særlige farer / sikkerhedsforskrifter

Slå tændingen fra:

1. Tryk på START-STOP-knappen uden at aktivere driftsbremsen.
2. Hold den elektroniske køretøjsnøgle i en afstand på mindst 5 m.

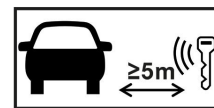

Fraværet af motorlyde betyder ikke, at køretøjet er slukket.



En genstart er mulig, indtil køretøjet tages ud af drift.

Deaktivering af højvoltssystemet



I tilfælde af ulykker, hvor airbags og forspændere til sikkerhedssele udløses, slås højvoltssystemet automatisk fra.





I alle andre tilfælde skal højvoltage systemet deaktiveres på følgende måde:

Mulighed 1: Højvoltsafbryder

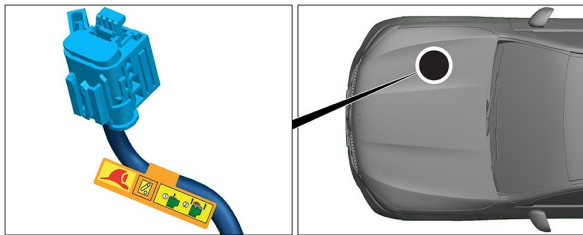

Højvoltsafbryderen sidder i motorrummet i passagersiden.



- (1) Træk i grebet til oplåsning
- (2) Tryk grebet til oplåsning nedad
- (3) Træk kontakten ud



Mulighed 2: Alternativ højvoltsafbryder

Den alternative højvoltsafbryder sidder under dækslet til sikringsboksen i cockpittet i førersiden. Den er afmærket.

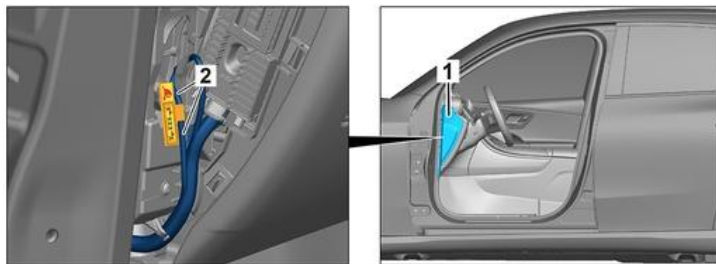

Fjern dækslet (1). Skær ledningen over ved det markerede punkt (2).



For at sikre, at der ikke er restspænding i højspændingsnettet, skal du vente cirka 20 sekunder efter afbrydelsen.



De passive sikkerhedssystemer såsom airbags og forspændere til sikkerhedssele forsynes fortsat med strøm fra 12-voltsledningsnettet.



Afbryd 12 V-batteriet

1. Fjern dækslet til 12-voltsbatteriet i motorrum.
2. Løsn minuskablet på 12-voltsbatteriet ved skrueforbindelsen, og sikr det mod utilsigtet kontakt.



De passive sikkerhedssystemer (airbags og forspændere til sikkerhedssele) deaktiveres.



4. Adgangveje til tilskadekommande

Ved frigørelse af personerne i bilen skal der tages hensyn til komponenterne i sikkerhedssystemerne (især pyrotekniske elementer) i overensstemmelse med angivelserne på side 1.

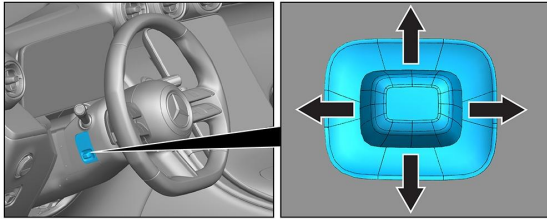

Ratindstilling

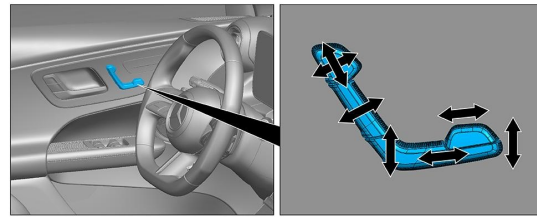

Sædeindstilling (elektrisk)

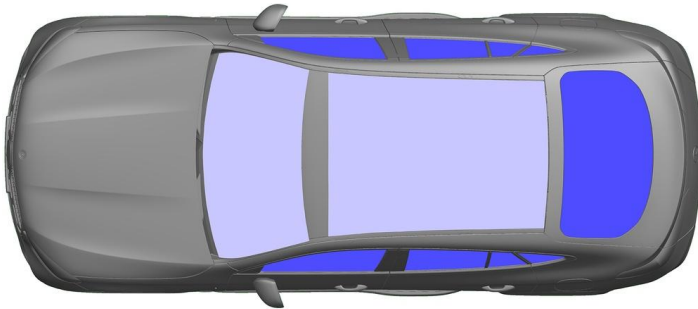

VSG: lamineret sikkerhedsglas
ESG: hærdet glas

5. Oplagret energi / væsker / gasser / faste stoffer



Alle højvoltsledninger er forsynet med en orangefarvet isolering.

6. I tilfælde af brand

Brug store mængder vand (H₂O), når en køretøjsbrand skal slukkes.
Brug store mængder vand (H₂O) til at afkøle li-ion-batteriet.

Advarsel: Genantændelse af batteriet



Hvis kølemiddel lækker fra højvoltsbatteriet, kan det blive ustabil på grund af termisk overbelastning. Kontrollér batteriets temperatur med et IR-varmefølsomt kamera.



7. I vand

Der er ingen fare ved, at der er spænding på karrosseriet.

Efter bjærgning af køretøjet:

1. Lad vandet løbe ud af kabinen.
2. Påbegynd deaktivering af højvoltage systemet (se kapitel 3).



8. Bugsering / transport / opbevaring

Transportér kun køretøjet med begge hjulsæt på et bugseringskøretøj eller en autotransporter.

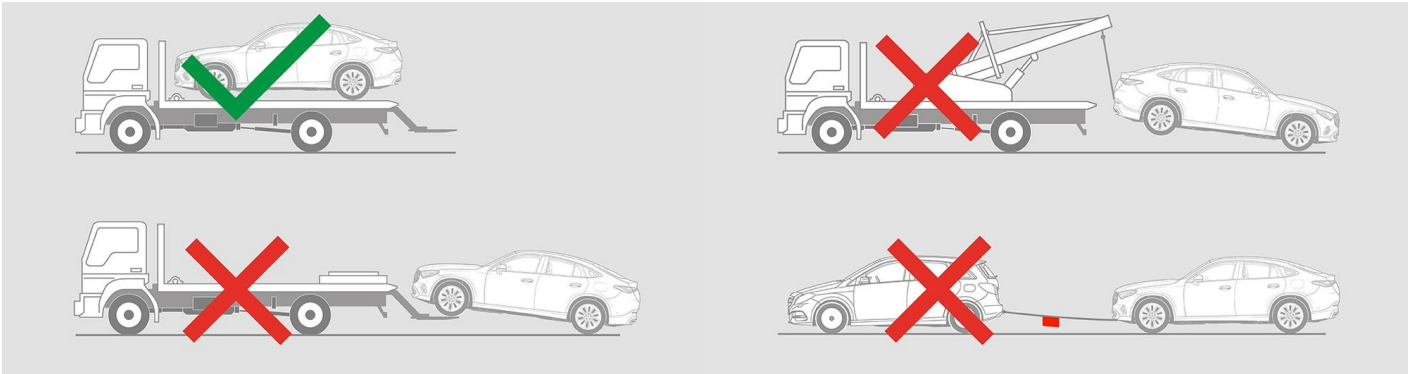

Opbevaring i sikker afstand af andre køretøjer.



Advarsel: Genantændelse af batteriet



9. Vigtige ekstra oplysninger

Yderligere oplysninger findes i [Vejledning for bjærgningsfirmaer, personvogne](#).

10. Piktogram information



Hybrid elektrisk køretøj på brændstof i klasse 2



Generelt advarselsskilt



Advarsel, elektricitet



Brandfarligt



Farligt for menneskers sundhed



Ætsende



Akut toksicitet



Brug vand til at slukke ilden



Brug termisk infrarødt kamera



Motorhjem



Fjern smart nøgle