









-  安全氣囊
-  氣體產生器
-  安全帶收緊裝置
-  輔助保護系統 (SRS) 控制單元
-  主動式行人保護系統
-  氣壓撐桿 / 氣動彈簧
-  低電壓電瓶
-  柴油機 燃油箱

提醒: 詳細訊息請參考 [救援指南](#)。



1. 確認/識別

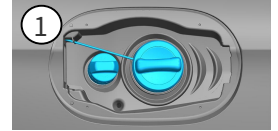

②
CLA 180d

2. 固定/穩定/升降

手煞車

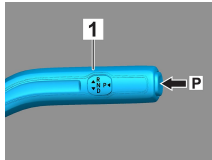

手煞車

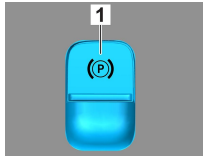

按下選檔桿 (1) 上的開關 P。電動手煞車即自動啟動。

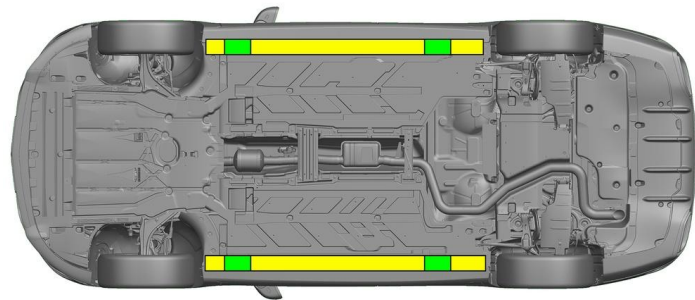

- 合適的升降點
- 側面合適的穩定點



救援期間必須避免車門門檻和車身底板發生額外的變形 (例如使用千斤頂支撐)。

3. 解除直接危害/安全規章

關閉點火開關：

1. 按下啟動/停止按鈕，而不要觸發主煞車。
2. 將電子車鑰匙放在至少 5 公尺之外。

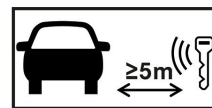

沒有引擎噪音並不表示車輛已關閉。



車輛關閉之前可以重新啟動。



斷開 12V 電瓶

1. 拆下引擎室內的 12 伏電池蓋。
2. 鬆開螺絲連接處的 12 伏電瓶負極電纜，並防止意外接觸。



被動安全系統 (安全氣囊和安全帶張緊器) 被停用。



4. 救援通道

在放開乘員時，請根據第 1 頁的資訊，注意乘員防護系統的元件（尤其是火藥元件）。

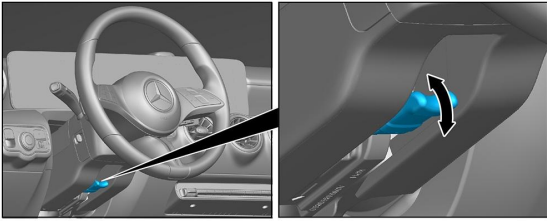

方向盤調節

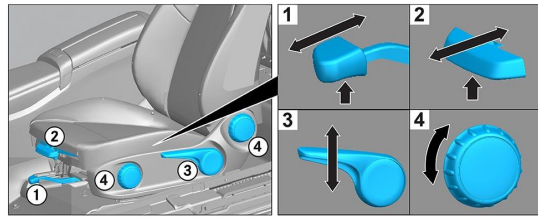

座椅調節 (手動)

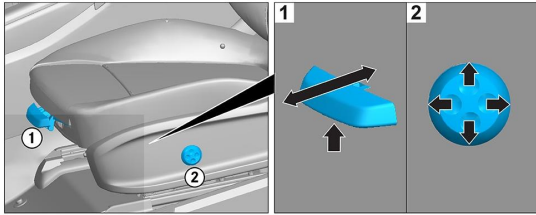

調整座椅 (電動)

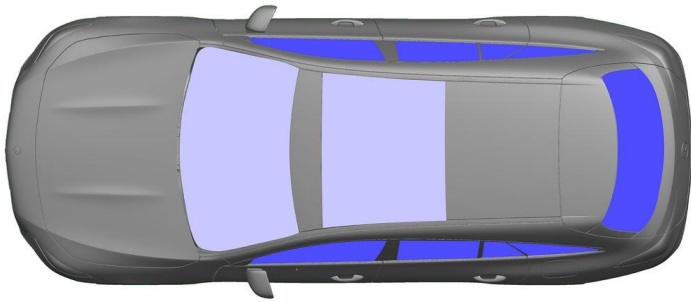

 VSG : 夾層安全玻璃

 ESG : 強化安全玻璃

5. 剩餘電量/液體/燃油/固體



6. 車輛起火



使用大量的水 (H₂O) 來撲滅車輛火災。

7. 車輛泡水

沒有電壓施加到車身的風險。車輛恢復後：

1. 讓水從內部排出。
2. 開始停用 12 V/48 V 車輛電氣系統 (參見第 3 章)。

8. 拖吊/運輸/存放

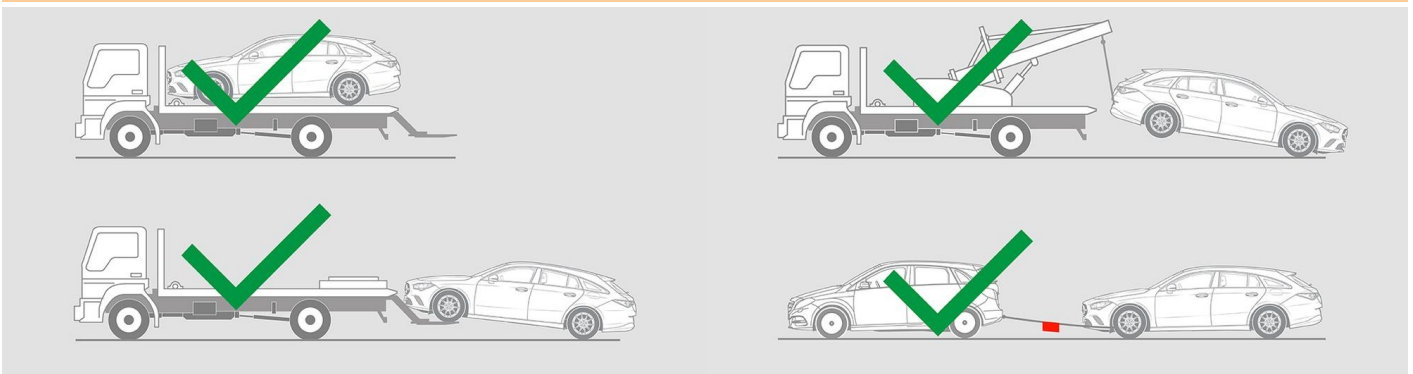



9. 其他重要訊息

更多訊息請參考 [拖吊服務指南](#)。

10. 使用圖示說明



使用第 1 组液体燃料的汽车



注意 / 警告



易燃物



對健康有害



腐蝕性物質



急性毒性



用水滅火



用干泡沫滅火



用湿泡沫滅火



移除智慧鑰匙