

-  安全氣囊
-  氣體產生器
-  安全帶收緊裝置
-  輔助保護系統 (SRS) 控制單元
-  主動式行人保護系統
-  氣壓撐桿 / 氣動彈簧
-  低電壓電瓶
-  汽油 燃油箱
-  高電壓電瓶
-  高壓電力電纜
-  高壓組件
-  電纜中斷
-  斷開高電壓的低壓裝置

提醒: 詳細訊息請參考 [救援指南](#)。

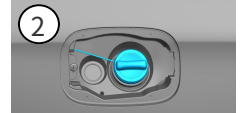

1. 確認/識別

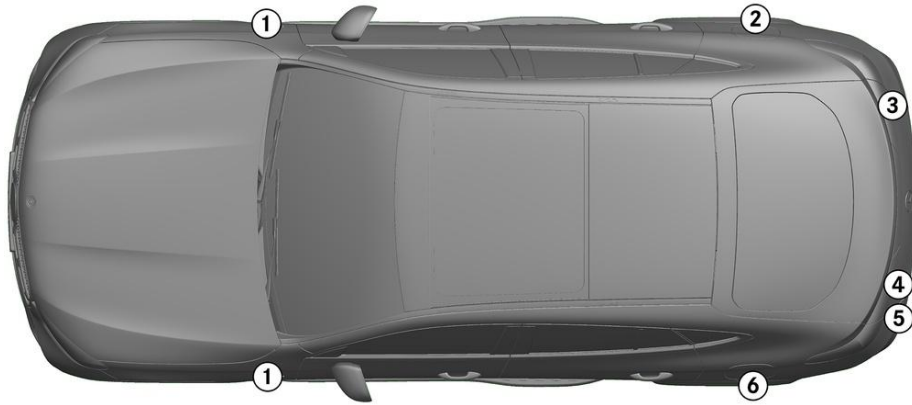

2. 固定/穩定/升降

手煞車

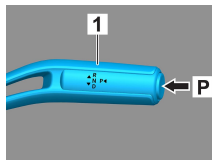

手煞車

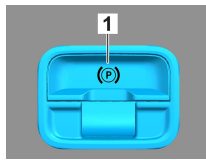

按下選檔桿 (1) 上的開關 P。電動手煞車即自動啟動。

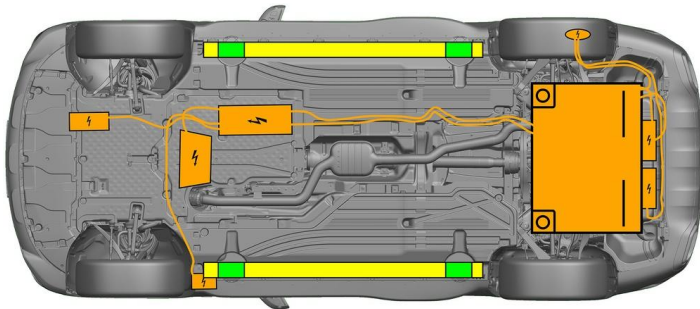

- 合適的升降點
- 側面合適的穩定點
- 高壓電池



救援期間必須避免車門門檻和車身底板發生額外的變形 (例如使用千斤頂支撐)。

3. 解除直接危害/安全規章

關閉點火開關：

1. 按下啟動/停止按鈕，而不要觸發主煞車。
2. 將電子車鑰匙放在至少 5 公尺之外。



沒有引擎噪音並不表示車輛已關閉。



車輛關閉之前可以重新啟動。

停用高壓系統



若事故發生時觸發了安全氣囊和安全帶收緊裝置，將會自動關閉高壓系統。





在必要的狀況下，高壓系統應依照以下方式關閉：

選項 1: 高壓斷開裝置

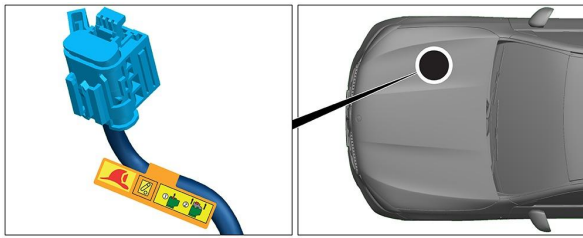

高壓斷開裝置位於 乘客側發動機 艙內。

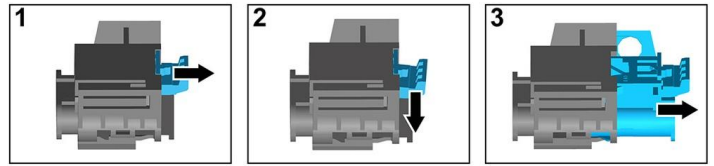

- (1) 拉釋放
- (2) 向下推釋放
- (3) 拔出開關



選項 2: 替代高壓斷開裝置

替代高壓斷開裝置位於駕駛艙駕駛員側的保險絲盒蓋下方，並且有標示提醒。

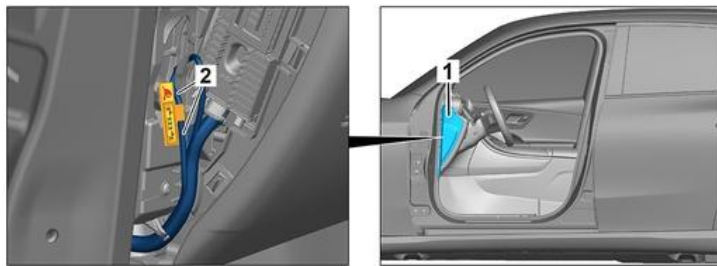

拆下蓋板 (1)。從標記點 (2) 處切斷電纜。



為確保高壓網絡中沒有殘餘電壓，請在關閉後等待約 20 秒。



安全氣囊和安全帶張緊器等被動安全系統繼續由 12 伏車輛電氣系統供電。



斷開 12V 電瓶

1. 拆下引擎室內的 12 伏電池蓋。
2. 鬆開螺絲連接處的 12 伏電瓶負極電纜，並防止意外接觸。



被動安全系統（安全氣囊和安全帶張緊器）被停用。



4. 救援通道

在放開乘員時，請根據第 1 頁的資訊，注意乘員防護系統的元件（尤其是火藥元件）。

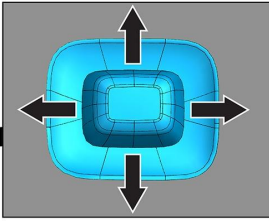
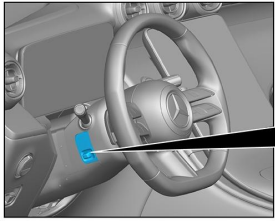

方向盤調節

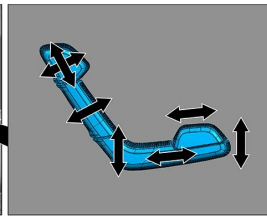
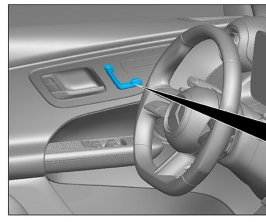

調整座椅 (電動)

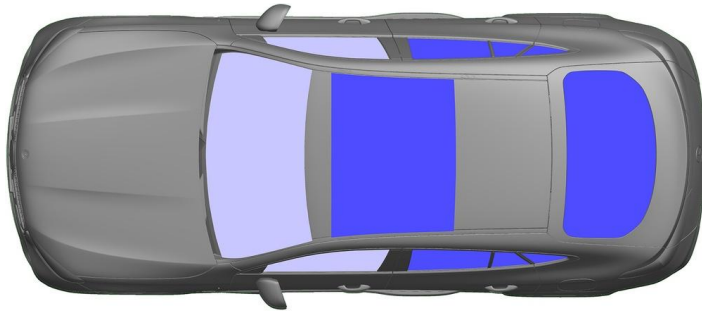

VSG：夾層安全玻璃

ESG：強化安全玻璃

5. 剩餘電量/液體/燃油/固體

		12V
		400V
		62L
		660 ± 10g



所有高壓電纜均具有橘色的絕緣層。

6. 車輛起火



使用大量的水 (H₂O) 滅火。
使用大量的水 (H₂O) 冷卻 電池。



警告：電池再次燃燒。



如果冷卻液從高壓電池洩漏，則冷卻液可能會由於熱過載而變得不穩定。使用紅外線熱像檢查電池溫度。



7. 車輛泡水

車身沒有通電的危險。拖吊車輛後：

1. 將車輛內的水排出。
2. 停用高壓系統（參考第 3 章）



8. 拖吊/運輸/存放

運輸車輛時，車輛的四輪都必須位於拖吊車或運輸車輛上。

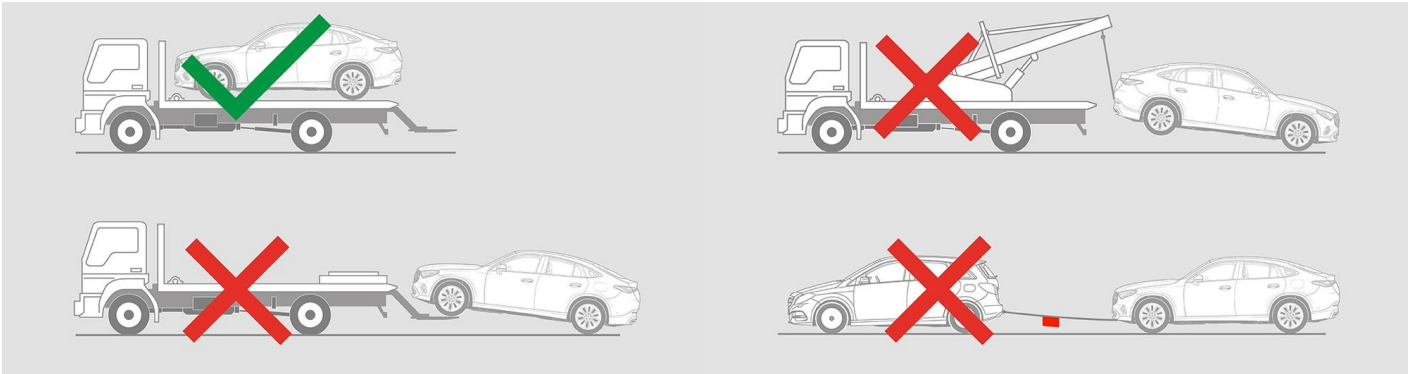

與其他車輛保持安全距離。



警告：電池再次燃燒。



9. 其他重要訊息

更多訊息請參考 [拖吊服務指南](#)。

10. 使用圖示說明



使用第 2 組液體燃料的車輛



注意 / 警告



電力警告



易燃物



對健康有害



腐蝕性物質



急性毒性



易爆



用水滅火



使用紅外線熱像儀



引擎蓋



移除智慧鑰匙



空調系統組件



警告，低溫