

- |   |   |  |   |   |
|---|---|--|---|---|
|  安全氣囊        |  氣體產生器 |  安全帶收緊裝置    |  輔助保護系統 (SRS) 控制單元 |  主動式行人保護系統 |
|  氣壓撐桿 / 氣動彈簧 |  低電壓電瓶 |  汽油 燃油箱     |  高電壓電瓶             |  高壓電力電纜    |
|  高壓組件         |  電纜中斷  |  斷開高電壓的低壓裝置 |   |   |

提醒: 詳細訊息請參考 [救援指南](#)。



## 1. 確認/識別



②  
**4MATIC**



④  
**E 350e**



## 2. 固定/穩定/升降

手煞車

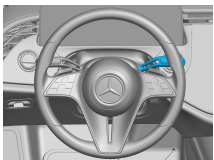

手煞車

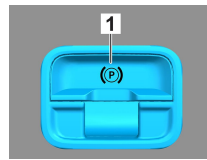
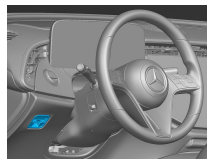

按下選檔桿 (1) 上的開關 P。電動手煞車即自動啟動。

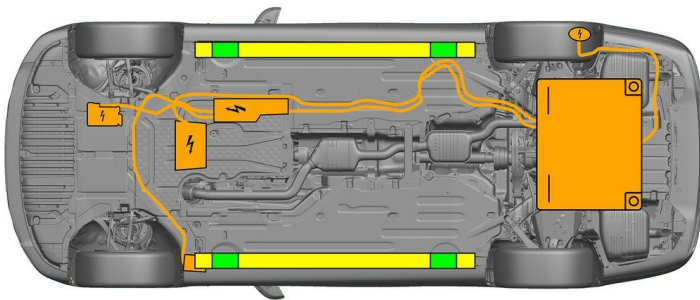

- 合適的升降點
- 側面合適的穩定點
- 高壓電池



救援期間必須避免車門門檻和車身底板發生額外的變形 (例如使用千斤頂支撐)。

## 3. 解除直接危害/安全規章

關閉點火開關：

1. 按下啟動/停止按鈕，而不要觸發主煞車。
2. 將電子車鑰匙放在至少 5 公尺之外。

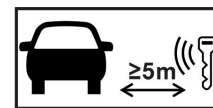

沒有引擎噪音並不表示車輛已關閉。



車輛關閉之前可以重新啟動。

停用高壓系統



若事故發生時觸發了安全氣囊和安全帶收緊裝置，將會自動關閉高壓系統。





在必要的狀況下，高壓系統應依照以下方式關閉：

選項 1: 高壓斷開裝置



高壓斷開裝置位於 乘客側發動機 艙內。



- (1) 拉釋放
- (2) 向下推釋放
- (3) 拔出開關



選項 2: 替代高壓斷開裝置

替代高壓斷開裝置位於駕駛艙駕駛員側的保險絲盒蓋下方，並且有標示提醒。

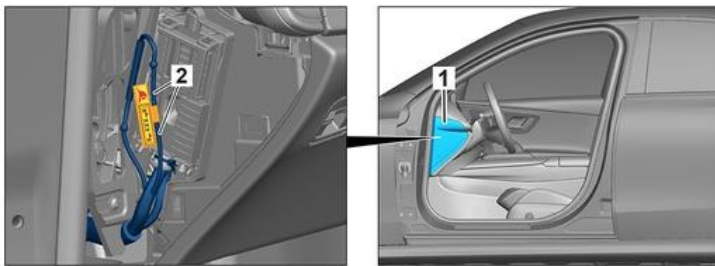

拆下蓋板 (1)。從標記點 (2) 處切斷電纜。



為確保高壓網絡中沒有殘餘電壓，請在關閉後等待約 20 秒。



安全氣囊和安全帶張緊器等被動安全系統繼續由 12 伏車輛電氣系統供電。



斷開 12V 電瓶

1. 拆下引擎室內的 12 伏電池蓋。
2. 鬆開螺絲連接處的 12 伏電瓶負極電纜，並防止意外接觸。



斷開 12V 電池

1. 拆下行李廂中的 12 伏電池蓋。
2. 鬆開螺絲連接處的 12 伏電瓶負極電纜，並防止意外接觸。



被動安全系統（安全氣囊和安全帶張緊器）被停用。



## 4. 救援通道

在放開乘員時，請根據第 1 頁的資訊，注意乘員防護系統的元件（尤其是火藥元件）。



取一扁平的非金屬物品，從上方將其插入隱藏門把 (1) 後方，然後將門把往外扳開。



由下方伸手至門把 (1) 後方，向外拉動直到感受到阻力，並且維持此狀態。

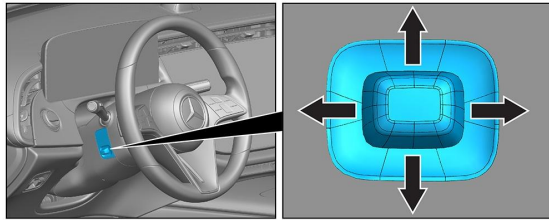

方向盤調節

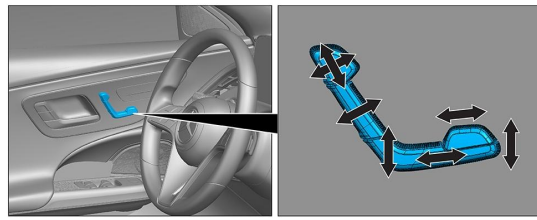

調整座椅 (電動)

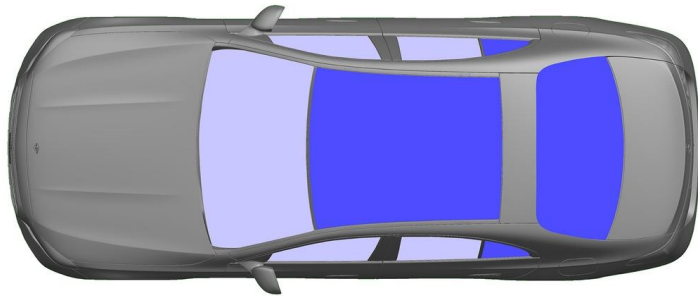

- VSG：夾層安全玻璃
- ESG：強化安全玻璃

## 5. 剩餘電量/液體/燃油/固體

	  	12V
	      	400V
	 	50L
	  	660 ± 10g



所有高壓電纜均具有橘色的絕緣層。



## 6. 車輛起火



使用大量的水 (H<sub>2</sub>O) 滅火。  
使用大量的水 (H<sub>2</sub>O) 冷卻 電池。



警告：電池再次燃燒。



如果冷卻液從高壓電池洩漏，則冷卻液可能會由於熱過載而變得不穩定。使用紅外線熱像檢查電池溫度。



## 7. 車輛泡水

車身沒有通電的危險。拖吊車輛後：

1. 將車輛內的水排出。
2. 停用高壓系統（參考第 3 章）

## 8. 拖吊/運輸/存放

運輸車輛時，車輛的四輪都必須位於拖吊車或運輸車輛上。

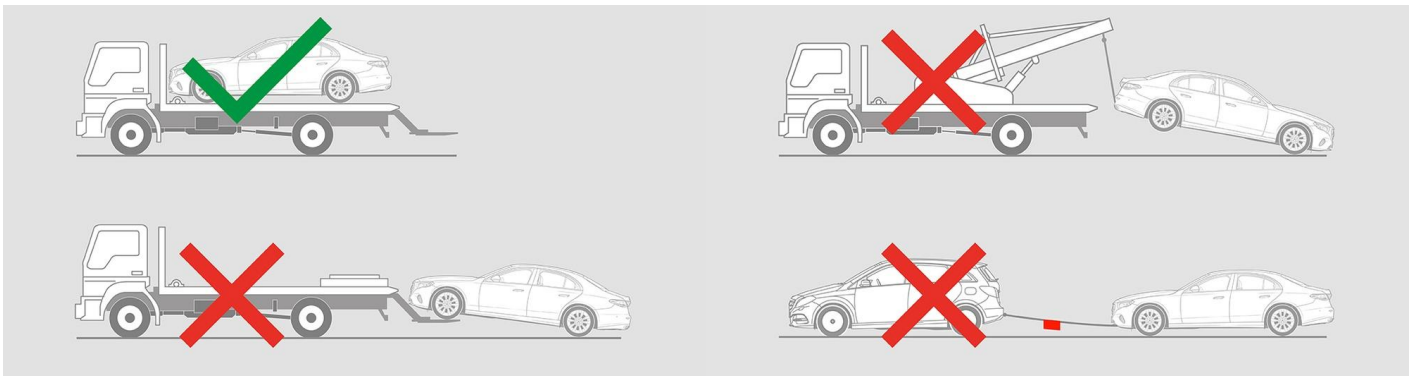

與其他車輛保持安全距離。



警告：電池再次燃燒。



## 9. 其他重要訊息

更多訊息請參考 [拖吊服務指南](#)。

## 10. 使用圖示說明



使用第 2 組液體燃料的車輛



注意 / 警告



電力警告



易燃物



對健康有害



腐蝕性物質



急性毒性



易爆



用水滅火



使用紅外線熱像儀



引擎蓋



行李廂



移除智慧鑰匙



空調系統組件



警告，低溫