



- ① 12 伏特電池
- ② 高電壓電池
- ③ 高電壓充電插座
- ④ 板載充電器
- ⑤ 12 伏特 輔助電瓶

 安全氣囊	 氣體產生器	 安全帶收緊裝置	 氣壓式避震器	 油箱
 乘員防護系統控制器	 12 伏特電瓶	 高電壓電瓶	 高壓電組件	 高電壓關閉裝置
 替代高電壓關閉裝置				

提醒: 詳細訊息請參考 [救援指南](#)。



1. 確認/識別

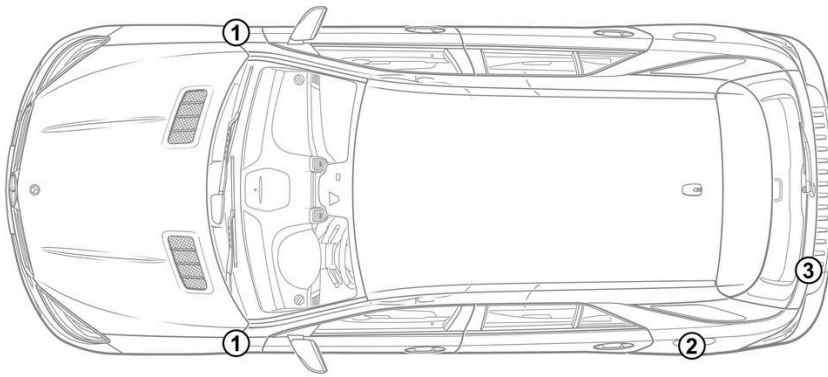

3. 解除直接危害/安全規章

停用高壓系統

在必要的狀況下，高壓系統應依照以下方式關閉：

選項 1: 高壓斷開裝置

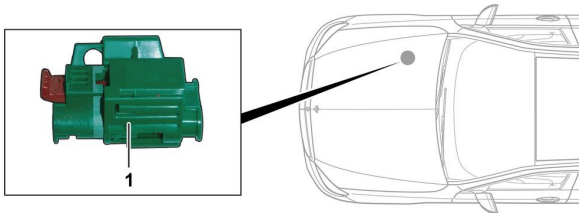

高壓斷開裝置位於 乘客側發動機 艙 內。

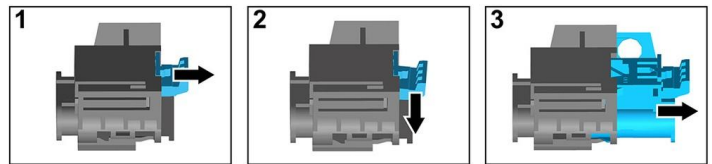

- (1) 拉釋放
- (2) 向下推釋放
- (3) 拔出開關



選項 2: 替代高壓斷開裝置

替代高壓斷開裝置位於駕駛艙駕駛員側的保險絲盒蓋下方，並且有標示提醒。

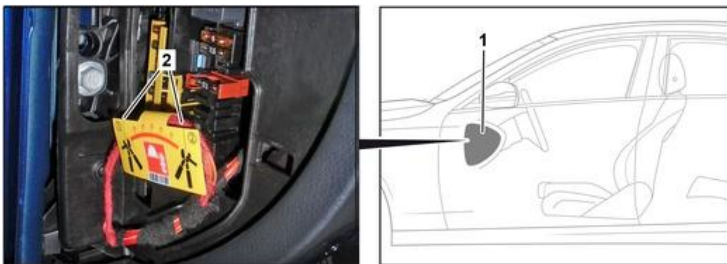

拆下蓋板 (1)。從標記點 (2) 處切斷電纜。



斷開 12V 電池

- 1. 取下 12 伏電池蓋。
- 2. 鬆開螺絲連接處的 12 伏電池負極電纜，並防止意外接觸。

