

① 12 伏特電池

② 12 伏特 輔助電瓶

③ 高電壓電池

④ 高電壓充電插座



安全氣囊

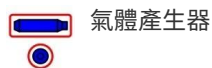

氣體產生器

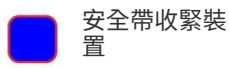

安全帶收緊裝置

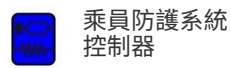

乘員防護系統  
控制器

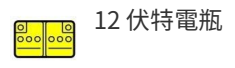

12 伏特電瓶

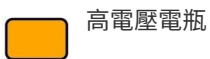

高電壓電瓶



高壓電組件

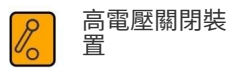

高電壓關閉裝置

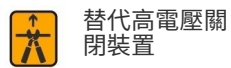

替代高電壓關  
閉裝置

提醒: 詳細訊息請參考 [救援指南](#)。



### 1. 確認/識別

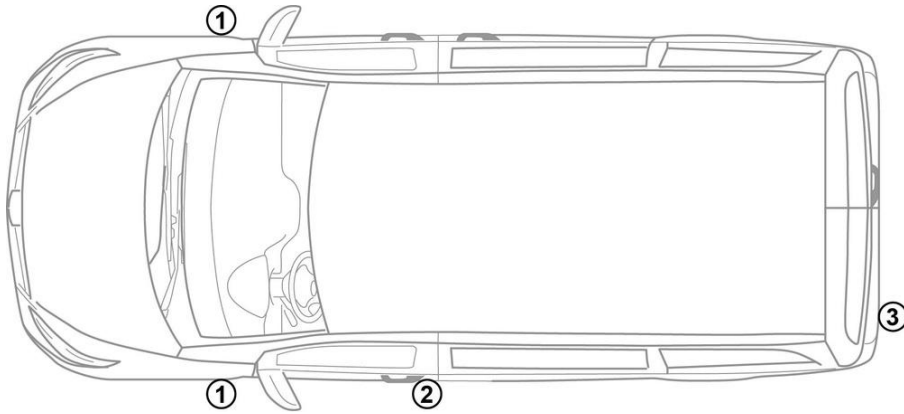

### 3. 解除直接危害/安全規章

#### 停用高壓系統

在必要的狀況下，高壓系統應依照以下方式關閉：

#### 選項 1: 高壓斷開裝置

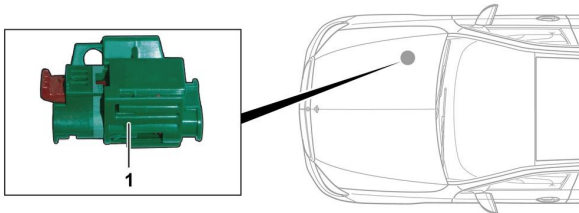

高壓斷開裝置位於 乘客側發動機 艙內。

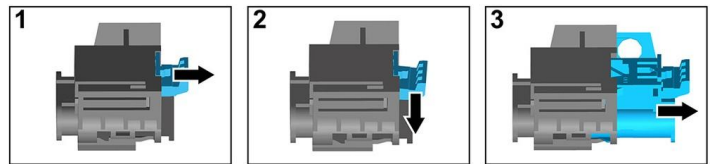

- (1) 拉釋放
- (2) 向下推釋放
- (3) 拔出開關

#### 選項 2: 替代高壓斷開裝置

替代高壓斷開裝置位於右前座的座椅底座上。它標有一個標誌。

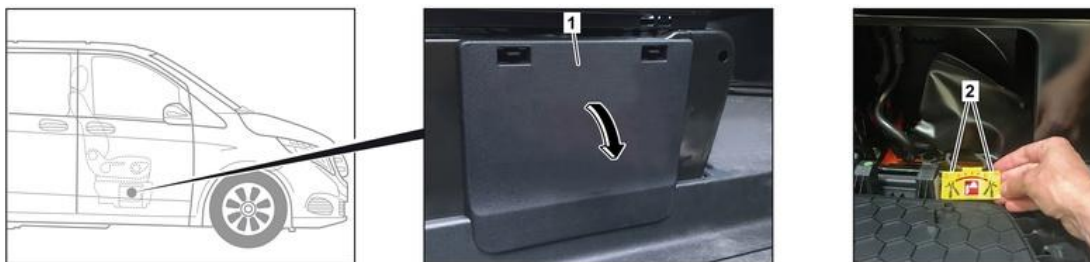

拆下蓋子 (1)。穿過標記點 (2) 處的線。



#### 斷開 12V 電池

- 1. 取下12 伏電池蓋。
- 2. 鬆開螺絲連接處的 12 伏電池負極電纜，並防止意外接觸。