

- | | | | | | | | | | |
|---|---|---|---------------------------|---|------------------------------|---|---|---|------------------------------------|
|  | Gaisa spilvens |  | Uzkrātās gāzes ģenerators |  | Drošības jostas nospiēgotājs |  | Papildu ierobežotājsistēmas vadības iekārta |  | Aktīvā gājēju aizsardzības sistēma |
|  | Gāzes amortizators / nospiēgotā atspere |  | Zemsprieguma akumulators |  | Benzīns degvielas tvertne | | | | |

Norāde: Papildu informāciju, lūdzu, skatiet mūsu [glābšanas dienestu vadlīnijās](#).



1. Identifikācija / apzīmējums



2. Imobilizācija / stabilizācija / celšana

Stāvbremze

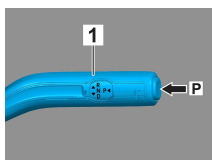

Stāvbremze

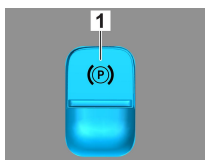

Nospiediet pārnesumu vadības sviras (1) slēdzi P. Stāvbremze tiek automātiski aktivizēta.

Elektriskā stāvbremze (1)

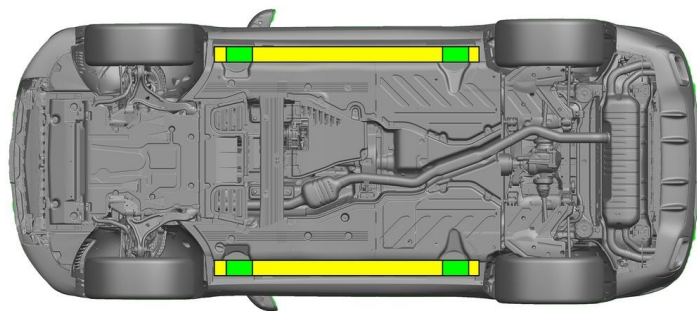

 Piemēroti pacelšanas punkti

 Piemēroti attiecīgās puses stabilizācijas punkti



Glābšanas darbu laikā jānovērš sliekšņu un grīdas papildu deformācija (piem., atbalstot ar hidraulikas aprīkojumu).

3. Tiešu bīstamību novēršana / drošības noteikumi

Aizdedzes izslēgšana:

1. Nospiediet IESLĒGŠANAS/IZSLĒGŠANAS pogu, nospiežot darba bremzes.
2. Novietojiet transportlīdzekļa elektronisko atslēgu vismaz 5 m attālumā.

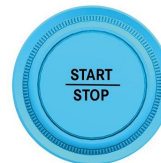
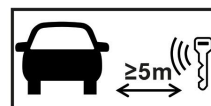

Tas, ka nav dzirdami motora trokšņi, nenozīmē, ka transportlīdzeklis ir izslēgts.



Atkārtota iedarbināšana ir iespējama līdz pat transportlīdzekļa ekspluatācijas pārtraukšanai.



12/48 V akumulatora atvienošana

1. Noņemiet 12/48 voltu akumulatora pārsegu.
2. Atskrūvējiet 12/48 voltu akumulatora mīnusa kabeļa skrūvsavienojumu un nodrošiniet pret nevēlamu kontaktu.



Pasīvās drošības sistēmas (gaisa spilveni un drošības jostas nosprīgotāji) tiek deaktivizēti.



4. Piekļuve braucējiem

Atbrīvojot pasažierus, ņemiet vērā noturēšanas sistēmu elementus (jo īpaši pirotehniskos elementus) saskaņā ar 1. lappusē sniegto informāciju.



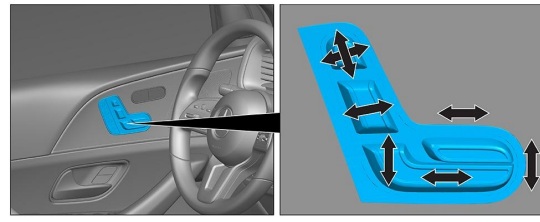

Stūres regulēšana



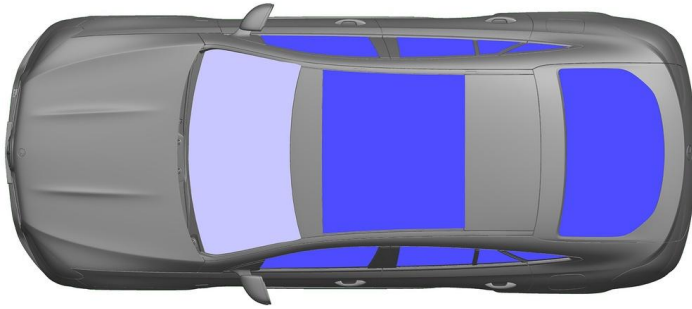











Sēdekļa regulēšana (elektriska)



 VSG: laminēts drošības stikls

 ESG: vienslāņa drošības stikls

5. Uzkrātā enerģija / šķidrums / gāzes / cietvielas

	    	12 V / 48 V
	 	85 L
	  	680 ± 10 g

6. Ugunsgrēka gadījumā



Dzēšot transportlīdzekļa ugunsgrēku, lietojiet lielu daudzumu ūdens (H₂O).

7. Iegremdēšanas gadījumā

Virsbūve nevada spriegumu un nerada apdraudējumu. Pēc transportlīdzekļa glābšanas:

1. Ļaujiet ūdenim izplūst no salona.
2. Sāciet 12/48 V borta elektrotīkla deaktivizāciju (skatiet 3. nodaļu).

8. Vilkšana / transportēšana / uzglabāšana

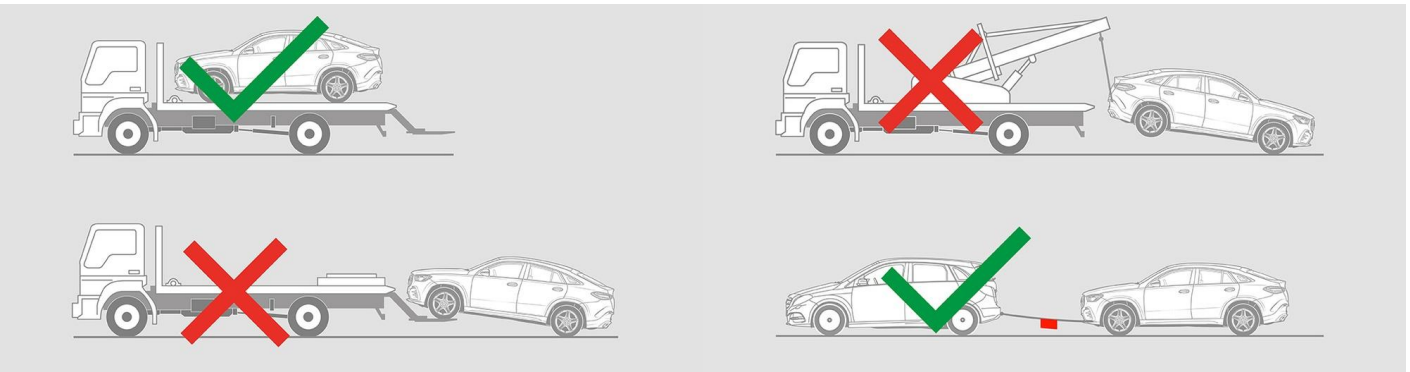

9. Svarīga papildinformācija

Papildu informāciju skatiet nodaļā [Eвакуācijas dienestiem paredzētās vadlīnijas par vieglajiem automobiļiem](#).



10. Izmantoto pictogrammu skaidrojums



Transportlīdzeklis, kuru darbina 2. grupas šķidrā degviela



Vispārēja brīdinājuma zīme



Uzliesmojošs



Bīstams cilvēka veselībai



Kodīgs



Akūts toksiskums



Sprādzienbīstams



Ugunsgrēku dzēst ar ūdeni



Ugunsgrēku dzēst ar sausajām putām



Ugunsgrēku dzēst ar mitrajām putām



Izņemt viedatslēgu



Gaisa kondicionēšanas sistēmas komponents



Brīdinājums, zema temperatūra