







-  Gaisa spilvens
-  Uzkrātās gāzes ģenerators
-  Drošības jostas nospiegotājs
-  Papildu ierobežotājsistēmas vadības iekārta
-  Gāzes amortizators / nospiegotā atspere
-  Zemsprieguma akumulators
-  Benzīns degvielas tvertne

Norāde: Papildu informāciju, lūdzu, skatiet mūsu [glābšanas dienestu vadlīnijās](#).



1. Identifikācija / apzīmējums



2. Imobilizācija / stabilizācija / celšana

Stāvbremze



Stāvbremze



Nospiediet pārnesumu vadības sviras (1) slēdzi P. Stāvbremze tiek automātiski aktivizēta.

Elektriskā stāvbremze (1)

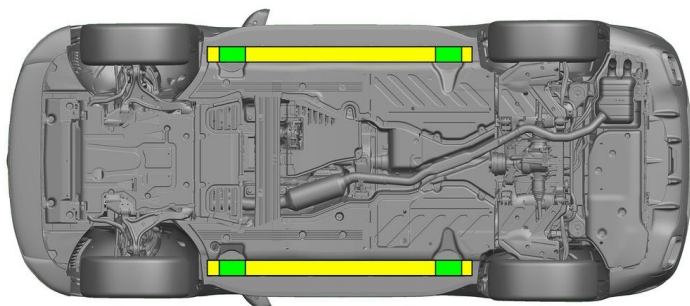

Piemēroti pacelšanas punkti



Piemēroti attiecīgās puses stabilizācijas punkti



Glābšanas darbu laikā jānovērš sliekšņu un grīdas papildu deformācija (piem., atbalstot ar hidraulikas aprīkojumu).

3. Tiešu bīstamību novēršana / drošības noteikumi

Aizdedzes izslēgšana:

1. Nospiediet IESLĒGŠANAS/IZSLĒGŠANAS pogu, nospiežot darba bremzes.
2. Novietojiet transportlīdzekļa elektronisko atslēgu vismaz 5 m attālumā.

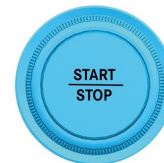
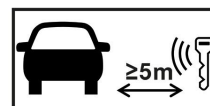

Tas, ka nav dzirdami motora trokšņi, nenozīmē, ka transportlīdzeklis ir izslēgts.



Atkārtota iedarbināšana ir iespējama līdz pat transportlīdzekļa ekspluatācijas pārtraukšanai.



12/48 V akumulatora atvienošana

1. Noņemiet 12/48 voltu akumulatora pārsegu.
2. Atskrūvējiet 12/48 voltu akumulatora mīnusa kabeļa skrūvsavienojumu un nodrošiniet pret nevēlamu kontaktu.



Pasīvās drošības sistēmas (gaisa spilveni un drošības jostas nosprīgotāji) tiek deaktivizēti.



4. Piekļuve braucējiem

Atbrīvojot pasažierus, ņemiet vērā noturēšanas sistēmu elementus (jo īpaši pirotehniskos elementus) saskaņā ar 1. lappusē sniegto informāciju.

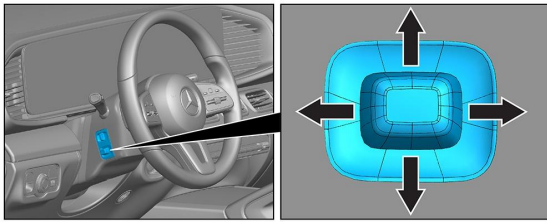

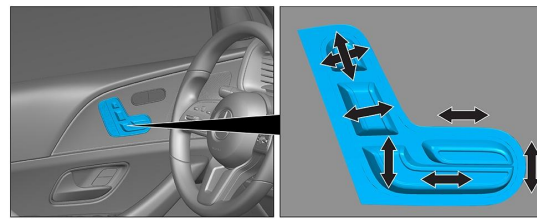

Stūres regulēšana



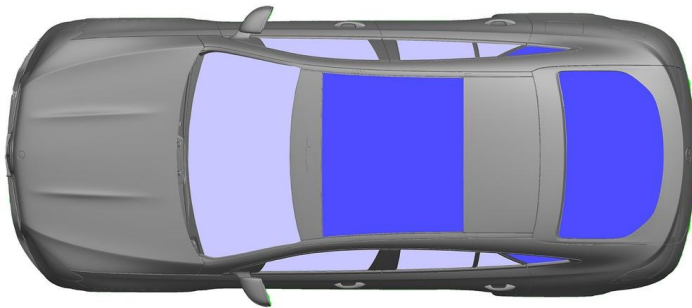











Sēdekļa regulēšana (elektriska)



 VSG: laminēts drošības stikls

 ESG: vienslāņa drošības stikls

5. Uzkrātā enerģija / šķidrums / gāzes / cietvielas

	    	12 V/ 48 V
	 	85 L
	  	660 ± 10 g

6. Ugunsgrēka gadījumā



Dzēšot transportlīdzekļa ugunsgrēku, lietojiet lielu daudzumu ūdens (H₂O).

7. Iegremdēšanas gadījumā

Virsbūve nevada spriegumu un nerada apdraudējumu. Pēc transportlīdzekļa glābšanas:

1. Ļaujiet ūdenim izplūst no salona.
2. Sāciet 12/48 V borta elektrotīkla deaktivizāciju (skatiet 3. nodaļu).

8. Vilkšana / transportēšana / uzglabāšana

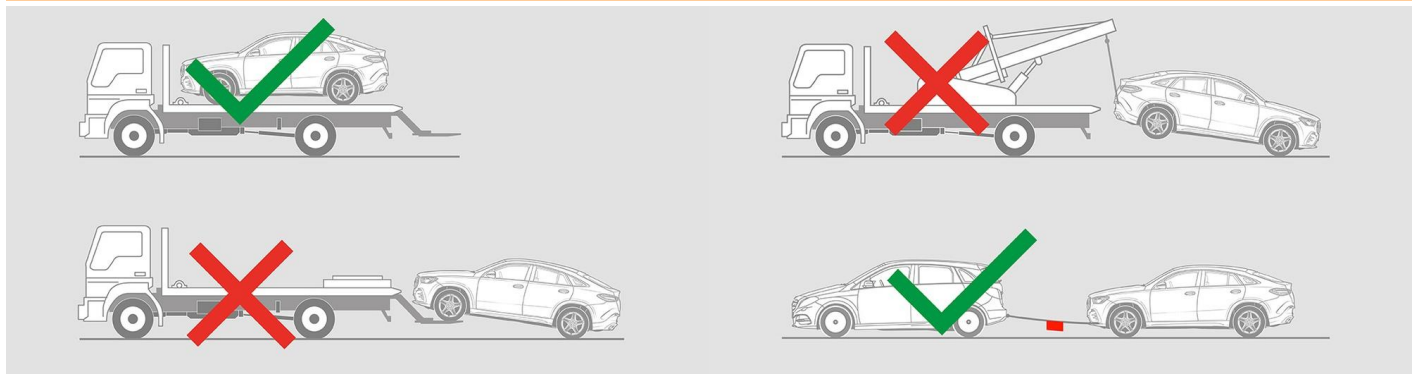

9. Svarīga papildinformācija

Papildu informāciju skatiet nodaļā [Eвакуācijas dienestiem paredzētās vadlīnijas par vieglajiem automobiļiem.](#)



10. Izmantoto piktogrammu skaidrojums



Transportlīdzeklis,
kuru darbina 2. grupas
šķidrā degviela



Vispārēja brīdinājuma
zīme



Uzliesmojošs



Bistams cilvēka veselī-
bai



Kodīgs



Akūts toksiskums



Ugunsgrēku dzēst ar
ūdeni



Ugunsgrēku dzēst ar
sausajām putām



Ugunsgrēku dzēst ar
mitrajām putām



Izņemt viedatslēgu