

- |                                                                                     |                                         |                                                                                     |                           |                                                                                     |                                                 |                                                                                     |                                             |                                                                                       |                                    |
|-------------------------------------------------------------------------------------|-----------------------------------------|-------------------------------------------------------------------------------------|---------------------------|-------------------------------------------------------------------------------------|-------------------------------------------------|-------------------------------------------------------------------------------------|---------------------------------------------|---------------------------------------------------------------------------------------|------------------------------------|
|  | Gaisa spilvens                          |  | Uzkrātās gāzes ģenerators |  | Drošības jostas nospiegotājs                    |  | Papildu ierobežotājsistēmas vadības iekārta |  | Aktīvā gājēju aizsardzības sistēma |
|  | Gāzes amortizators / nospiegotā atspere |  | Zemsprieguma akumulators  |  | Benzīns degvielas tvertne                       |  | Akumulators, augstsprieguma                 |  | Augstsprieguma barošanas vads      |
|   | Augstsprieguma komponents               |  | Kabeļa pārrāvums          |  | Zemsprieguma ierīce, kas atvieno augstspriegumu |                                                                                     |                                             |                                                                                       |                                    |

Norāde: Papildu informāciju, lūdzu, skatiet mūsu [glābšanas dienestu vadlīnijās](#).

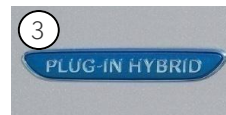

## 1. Identifikācija / apzīmējums

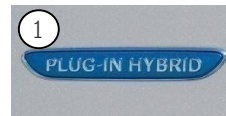
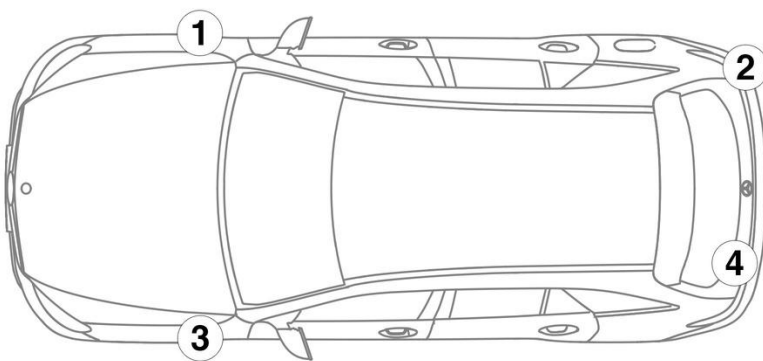

## 3. Tiešu bīstamību novēršana / drošības noteikumi

### Augstsprieguma sistēmas deaktivizācija

Pārējos gadījumos augstsprieguma sistēma jādeaktivizē šādi:

#### Iespēja 1: Augstsprieguma izslēgšanas ierīce

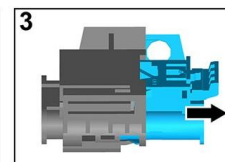
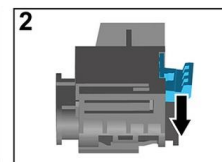
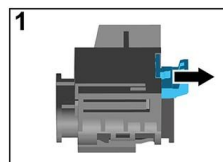
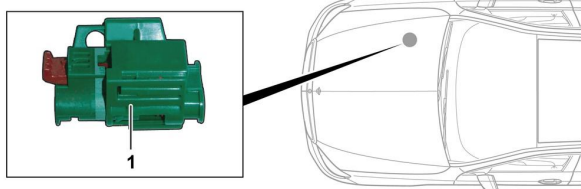

Augstsprieguma atvienošanas ierīce atrodas dzinēja nodalījumā, pasažiera pusē.



- (1) Pavelciet atbloķēšanas sviru
- (2) Spiediet atbloķēšanas sviru lejup
- (3) Izvelciet slēdzi



#### Iespēja 2: Alternatīva augstsprieguma izslēgšanas ierīce

Alternatīvā augstsprieguma atvienošanas ierīce atrodas salonā zem vadītāja pusē novietotās drošinātāju kārbas pārsega. Tā ir apzīmēta ar norādes plāksnīti.

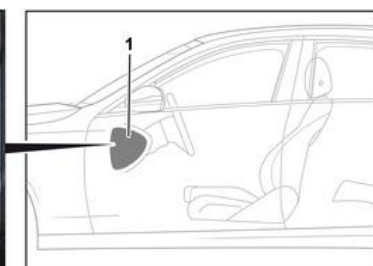

Noņemiet pārsegu (1). Pārgrieziet vadu marķētajā pozīcijā (2).



#### 12 V akumulatora atvienošana

1. Noņemiet 12 voltu akumulatora pārsegu.
2. Atskrūvējiet 12 voltu akumulatora mīnusa kabeļa skrūvsavienojumu un nodrošiniet pret nevēlamu kontaktu.