













-  Gaisa spilvens
-  Uzkrātās gāzes ģenerators
-  Drošības jostas nospiegotājs
-  Papildu ierobežotājsistēmas vadības iekārta
-  Gāzes amortizators / nospiegotā atspere
-  Zemsprieguma akumulators
-  Benzīns degvielas tvertne
-  Akumulators, augstsprieguma
-  Augstsprieguma barošanas vads
-  Augstsprieguma komponents
-  Kabeļa pārrāvums
-  Zemsprieguma ierīce, kas atvieno augstspriegumu

Norāde: Papildu informāciju, lūdzu, skatiet mūsu [glābšanas dienestu vadlīnijās](#).



1. Identifikācija / apzīmējums

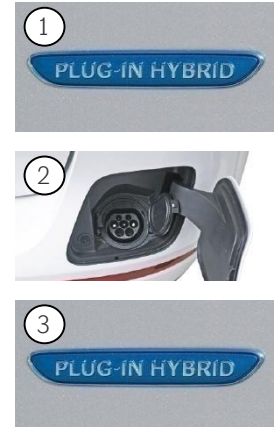
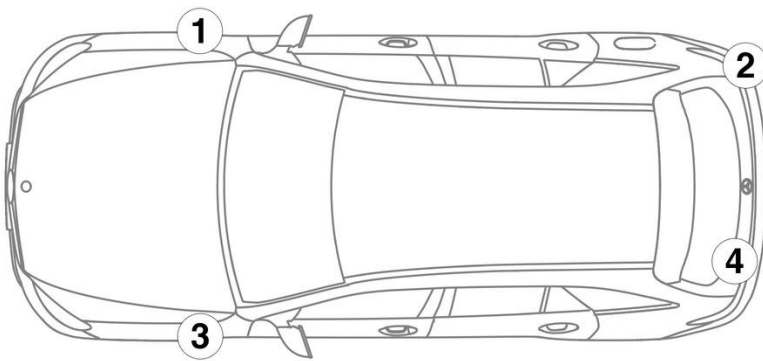

3. Tiešu bīstamību novēršana / drošības noteikumi

Augstsprieguma sistēmas deaktivizācija

Pārējos gadījumos augstsprieguma sistēma jādeaktivizē šādi:

Iespēja 1: Augstsprieguma izslēgšanas ierīce

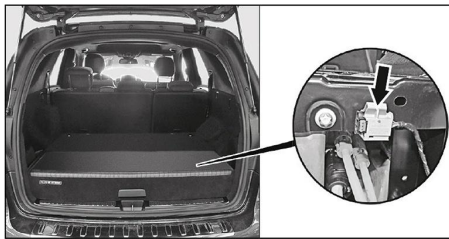

The high-voltage disconnect device is located in the trunk under the cover of the high-voltage battery.

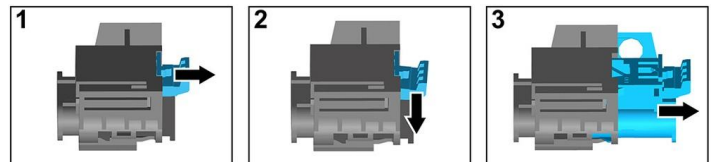

- (1) Pull the release
- (2) Push the release down
- (3) Pull out the switch



Iespēja 2: Alternatīva augstsprieguma izslēgšanas ierīce

The alternative high-voltage disconnect device is located behind the cover at the bottom of the right A-pillar. It is marked with an information label.

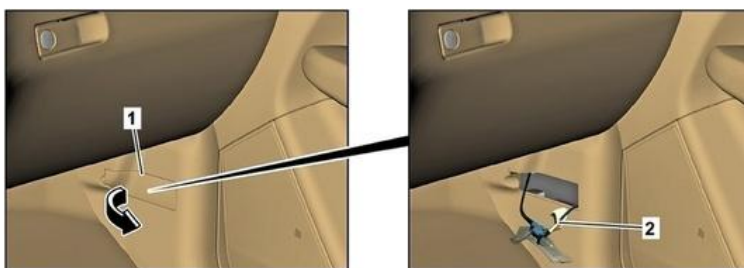

Remove cover (1) of fuse box / Cut line at marked location (2)



Gaidiet aptuveni 20 sekundes, lai pārliecinātos, ka augstsprieguma tīklā nav saglabājies atlikušais spriegums.



Pasīvo drošības sistēmu – gaisa spilvenu un drošības jostas nospriegotāju barošana tiek turpināta ar 12 voltu borta elektrotīklu.



12 V akumulatora atvienošana

1. Noņemiet 12 voltu akumulatora pārsegu.
2. Atskrūvējiet 12 voltu akumulatora mīnusa kabeļa skrūvsavienojumu un nodrošiniet pret nevēlamu kontaktu.