







-  Oro pagalvė
-  Dujų atsargų pripūtimo įtaisas
-  Saugos diržo įtempiklis
-  SRS valdymo blokas
-  Dujų stovas / išankstinės apkrovos spyruoklės
-  Žemos įtampos akumulatorius
-  Benzinas kuro bakas

Nurodymas: Daugiau informacijos rasite mūsų [gelbėjimo gairėse](#).



1. Identifikavimas / pripažinimas



2. Imobilizavimas / stabilizavimas / kėlimas

Stovėjimo stabdys



Stovėjimo stabdys



Paspauskite jungiklį P ant valdymo svirties (1).
Stovėjimo stabdys įjungiamas automatiškai.

Elektrinis stovėjimo stabdys (1)

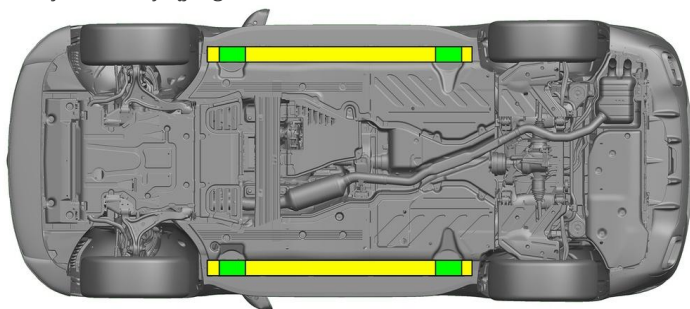

- Tinkami kėlimo taškai
- Tinkami stabilizavimo taškai šone



Gelbėjant reikia vengti papildomai deformuoti slenksčius ir dugną (pvz., atremiant su hidrauline įranga).

3. Apribokite tiesioginį pavojų / saugos taisyklės

Išjungti uždegimą:

1. Spauskite PALEIDIMO ir SUSTABDYMO mygtuką neįjungdami darbinio stabdžio.
2. Elektroninį transporto priemonės raktą laikykite ne arčiau kaip 5 m atstumu.



Jei nesigirdi variklio garsų, tai dar nereiškia, kad transporto priemonė yra išjungta.



Galima paleisti iš naujo iki baigiant naudoti transporto priemonę.



Atjungti 12 V / 48 V akumuliatorių

1. Nuimti 12 V / 48 V akumuliatoriaus dangtį.
2. Atjungti 12 V / 48 V akumuliatoriaus neigiamojo gnybto laidą prie varžtinio sujungimo ir apsaugoti nuo nepageidaujamo kontakto.



Pasyviosios saugos sistemos (oro pagalvės ir saugos diržų įtempikliai) išjungiamos.



4. Prieiga keleiviams

Išlaisvinant keleivius, reikia atsižvelgti į įtempimo sistemų komponentus (ypač į pirotechnikos elementus) pagal 1 puslapyje pateiktus duomenis.



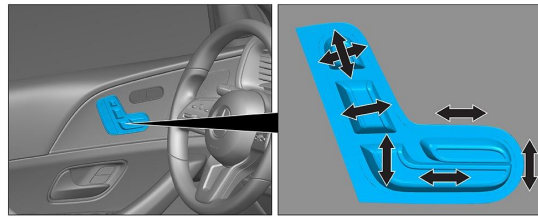

Vairo nustatymas



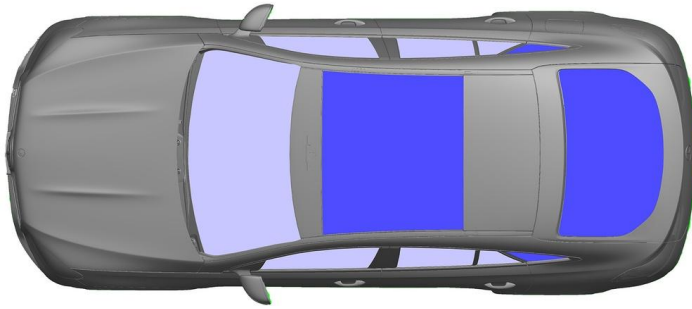











Sėdynės nustatymas (elektrinis)



 VSG: laminuotas stiklas

 ESG: grūdintas stiklas

5. Sukauptoji energija / skysčiai / dujos / kietos medžiagos

	    	12/48V
	 	85L
	  	660 ± 10g

6. Gaisro atveju



Transporto priemonės gaisrui gesinti reikia naudoti didelį vandens kiekį (H₂O).

7. Nugrimzdimo atveju

Nėra jokio pavojaus, kad kėbulas bus su įtampa. Po transporto priemonės gelbėjimo:

1. Vandeniui leisti ištekėti iš salono.
2. Išjungti 12 V / 48 V elektros sistemą (žr. 3 skyrių).

8. Vilkimas / gabenimas / sandėliavimas

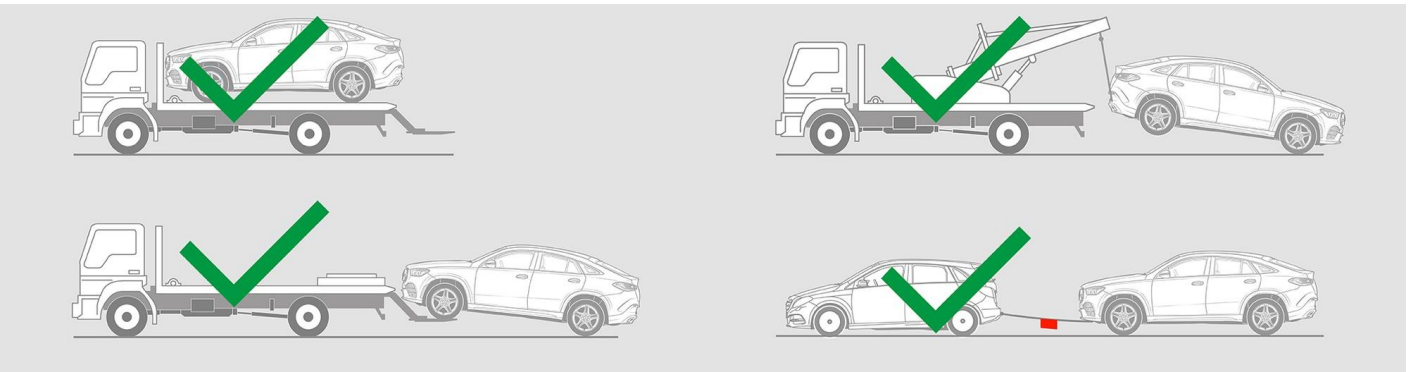

9. Svarbi papildoma informacija

Daugiau informacijos rasite [Gairės lengvųjų automobilių vilkimo tarnyboms](#).



10. Naudotų piktogramų paaiškinimas



Transporto priemonė, naudojanti 2-osios grupės skystąjį kurą



Bendrasis įspėjamasis ženklas



Degus



Pavojinga žmogaus sveikatai



Ėsdinančios medžiagos



Ūmus toksiškumas



Gaisrui gesinti naudokite vandenį



Gaisrui gesinti naudokite sausas putas



Gaisrui gesinti naudokite šlapias putas



Pašalinkite išmanųjį raktą