







① Left-hand drive

② Right-hand drive

-  Oro pagalvė
-  Dujų atsargų pripūtimo įtaisas
-  Saugos diržo įtempiklis
-  Dujų stovas / išankstinės apkrovos spyruoklės
-  Didelio stiprio zona
-  Žemos įtampos akumuliatorius
-  Benzinas kuro bakas

Nurodymas: Daugiau informacijos rasite mūsų [gelbėjimo gairėse](#).



1. Identifikavimas / pripažinimas

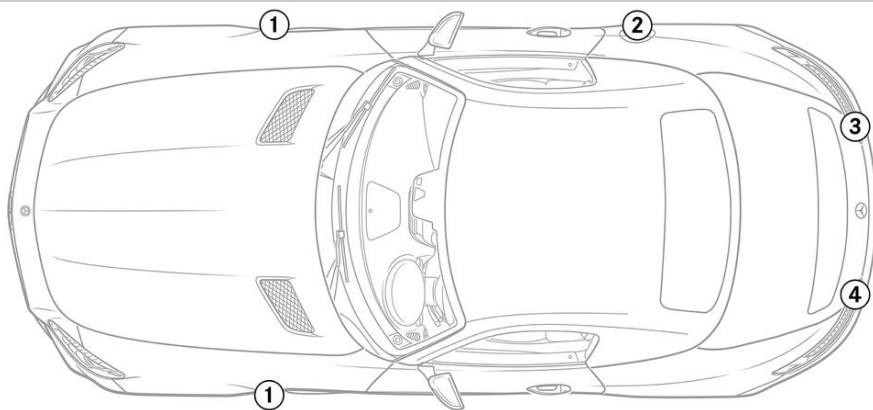

1

**V8 BITURBO**

2

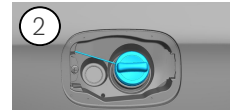

3

**GT**

4

