







48 V
Li-ion

12V
AGM

-  에어백
-  가스 발전기
-  안전벨트 텐서
너
-  SRS 컨트롤 유
닛
-  가스 압력 댐
퍼/프리텐션 스
프링
-  저전압 배터리
-  휘발유 연료 탱
크

참고 사항: 자세한 내용은 [구조 안내서](#) 참조.



1. 식별/인식



2. 고정 / 안정화 / 리프팅

주차 브레이크

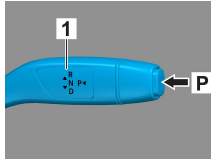
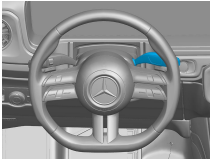

주차 브레이크

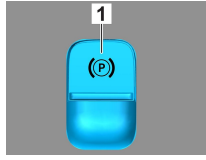
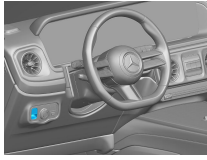

선택기 레버(1)의 스위치 P를 누르십시오.
주차 브레이크가 자동으로 활성화됩니다.

전자 주차 브레이크 (1)

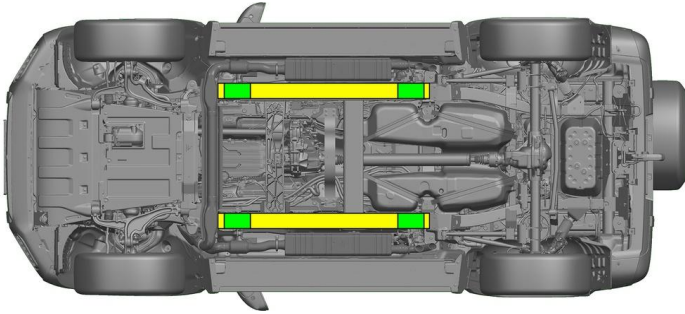

적합한 인양 지점

측면의 적합한 안정화 지점



구조하는 중 로커 패널과 언더바디의 추가적인 변형(예: 유압 장비로 지지)이 없도록 유의해야 합니다.

3. 직접적인 위험 제거 / 안전 규정 준수

점화 장치 끄기:

1. 주 브레이크를 밟지 않은 상태에서 START-STOP 버튼을 누르십시오.
2. 전자 차량 키를 5m 이상의 거리에 두십시오.



엔진 소음이 없다고 해서 차량이 꺼져 있는 것은 아닙니다.



차량이 종료될 때까지 재시동이 가능합니다.



48V 배터리 분리

1. 트렁크 접지 패드를 탈거하십시오(4개 고정 러그 분리). 이어서 다양한 트림(C 필러, D 필러, 차량 모서리 등)을 탈거하여 48V 배터리에 접근할 수 있도록 하십시오
2. 48V 배터리의 음극 케이블을 나사 연결부에서 푼 후 달지 않도록 고정하십시오.





12V 배터리 분리

- 12V 배터리에 접근할 수 있도록 트렁크 접지 패드를 탈거하십시오(4개 고정 러그 분리).
- 12V 배터리의 음극 케이블을 나사 연결부에서 푼 후 달지 않도록 고정하십시오.



수동 보안 시스템(에어백 및 안전벨트 텐서너)이 비활성화됩니다.

4. 요구조자(탑승자)에 접근

탑승자를 구조할 때 1페이지에 명시된 대로 강인강으로 만들어진 차체 영역과 구속 시스템의 구성요소(특히 폭약식 요소)를 고려해야 합니다.

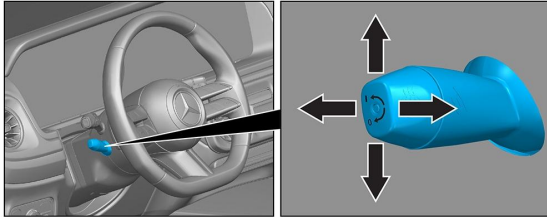

스티어링 휠 조정

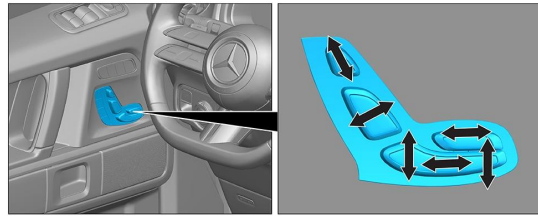

시트 조정(전동식)



VSG: 접합안전유리

ESG: 강화 안전 유리

5. 저장된 에너지/액체/가스/고체

		12/48V
		100L
		680 ± 10g

6. 화재 시



차량 화재를 진압하려면 다량의 물(H₂O)을 사용하십시오.

7. 침수 시

차체에 전압이 남아 있을 위험이 없습니다. 차량 구조 후:

- 내부의 물을 배출시키십시오.
- 12V/48V 차량 전원 시스템의 비활성화를 시작하십시오(3장 참조).



8. 견인/운송/보관

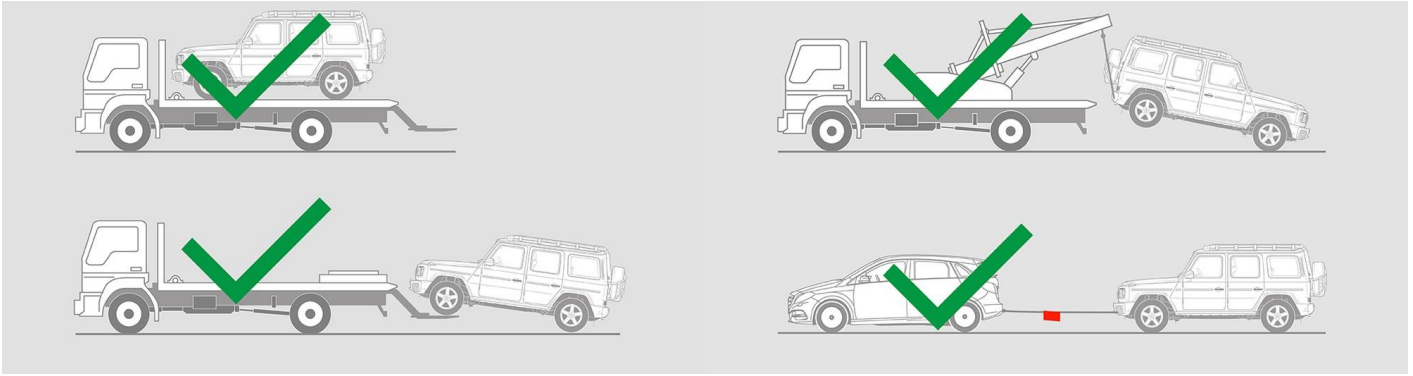

9. 중요 추가 정보

자세한 내용은 [견인 서비스 지침](#), 승용차 에서 확인할 수 있습니다.

10. 사용된 픽토그램 설명



차량, 2급 액체 연료
주입



위험



가연성



건강에 위험



부식성



폭발성



물로 끄기



드라이폼으로 끄기



웻 폼으로 끄기



트렁크



스마트 키 제거



Air-conditioning
component



Warning; low
temperature