

-  에어백
-  가스 발전기
-  안전벨트 텐서너
-  SRS 컨트롤 유닛
-  가스 압력 댐퍼/프리텐션 스프링
-  저전압 배터리
-  고전압 배터리
-  고전압 케이블
-  고전압 콤포넌트
-  대체 고전압 분리 장치
-  고전압 분리 지점 (저전압 요소)

참고 사항: 자세한 내용은 [구조 안내서](#) 참조.

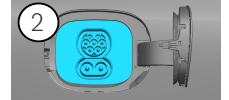

1. 식별/인식

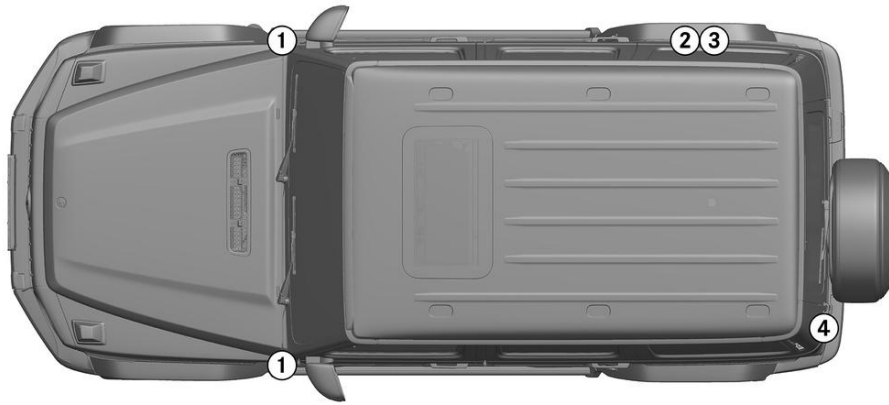

2. 고정 / 안정화 / 리프팅

주차 브레이크

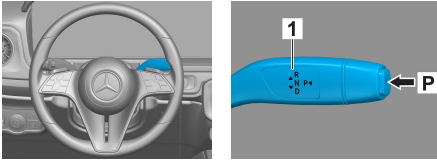

선택기 레버(1)의 스위치 P를 누르십시오. 주차 브레이크가 자동으로 활성화됩니다.

주차 브레이크



전자 주차 브레이크 (1)

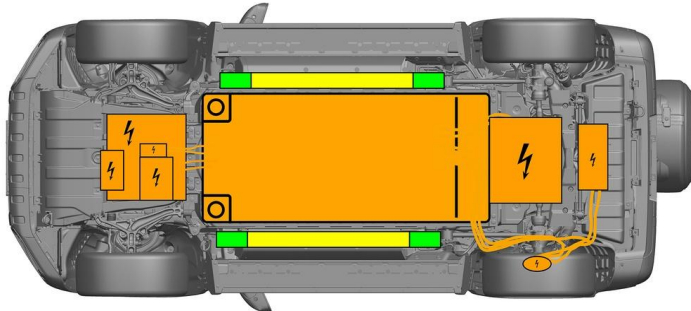

- 적합한 인양 지점
- 측면의 적합한 안정화 지점
- 고전압 배터리



구조하는 중 로커 패널과 언더바디의 추가적인 변형(예: 유압 장비로 지지)이 없도록 유의해야 합니다.

3. 직접적인 위험 제거 / 안전 규정 준수

점화 장치 끄기:

- 주 브레이크를 밟지 않은 상태에서 START-STOP 버튼을 누르십시오.
- 전자 차량 키를 5m 이상의 거리에 두십시오.

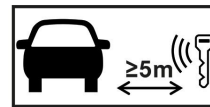

엔진 소음이 없다고 해서 차량이 꺼져 있는 것은 아닙니다.



차량이 종료될 때까지 재시동이 가능합니다.

고전압 시스템 비활성화



에어백과 안전벨트 텐서너를 작동시키는 사고가 발생할 경우 고전압 시스템이 자동으로 꺼집니다.





다른 모든 경우에는 다음과 같이 고전압 시스템을 비활성화해야 합니다.

옵션 1: 고압 분리 장치

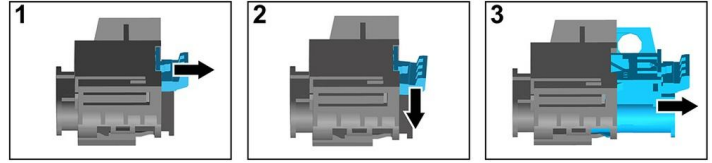
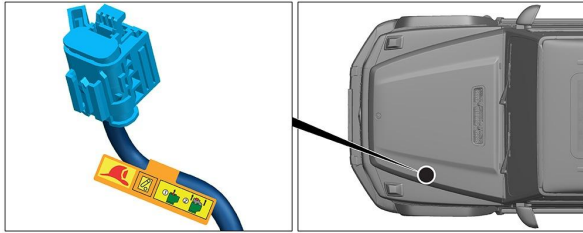

고전압 차단 장치는 엔진실 운전석 측에 위치합니다.



- (1) 잠금 해제 장치 당기기
- (2) 잠금 해제 장치 아래로 누르기
- (3) 스위치 당겨 빼기

옵션 2: 대체 고압 분리 장치



대체 고전압 분리 장치는 동반석 측 A-필러 아래에 있습니다. 정보 라벨이 부착되어 있습니다.

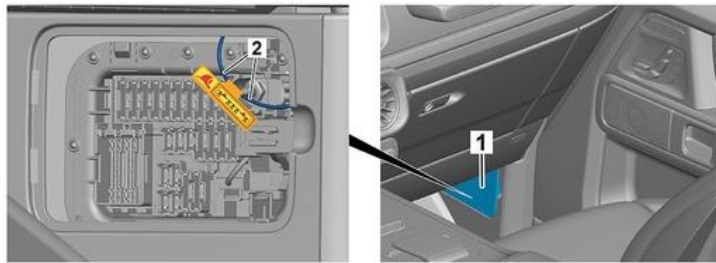

커버 (1)을 제거하십시오. 라인의 표시된 위치 (2)에서 잘라내십시오.



고전압 네트워크에 잔류 전압이 없는지 확인하려면 스위치를 끈 후 약 20초 동안 기다리십시오.



에어백 및 안전벨트 텐서너와 같은 수동 보안 시스템은 12V 차량 전원 시스템에 의해 계속해서 전원이 공급됩니다.



12V 배터리 분리

1. 12V 배터리 커버 제거.
2. 12V 배터리의 음극 케이블을 볼트 체결부에서 푼 후 의도치 않게 접촉되지 않도록 보호하십시오.



12V 배터리 분리

1. 12V 배터리 커버를 트렁크에서 제거하십시오. 관련 서비스 커버는 좌측 측면 패널에 있습니다.
2. 12V 배터리의 음극 케이블을 나사 연결부에서 푼 후 닿지 않도록 고정하십시오.



수동 보안 시스템(에어백 및 안전벨트 텐서너)이 비활성화됩니다.



4. 요구조자(탑승자)에 접근

탑승자를 구조할 때 1페이지에 명시된 대로 강인강으로 만들어진 차체 영역과 구속 시스템의 구성요소(특히 폭약식 요소)를 고려해야 합니다.

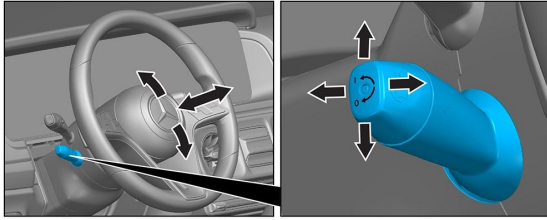

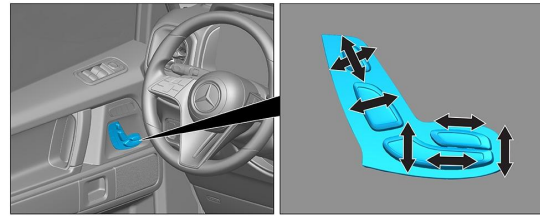

스티어링 휠 조정



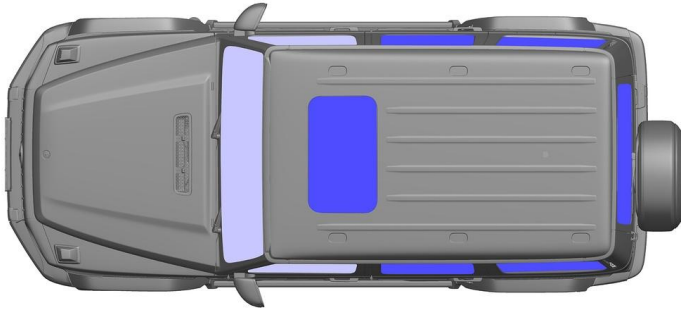













시트 조정(전동식)



 VSG: 접합안전유리

 ESG: 강화 안전 유리

5. 저장된 에너지/액체/가스/고체

	  	12V
	     	400V
	  	830 ± 10g

 모든 고전압 라인은 주황색 절연재와 함께 제공됩니다.

6. 화재 시



차량 화재를 진압하려면 다량의 물(H₂O)을 사용하십시오.
리튬 이온 배터리를 냉각하려면 다량의 물(H₂O)을 사용하십시오.



경고: 배터리의 재점화



고전압 배터리에서 냉각수가 누출되면 열 과부하로 인해 고전압 배터리가 불안정해질 수 있습니다. IR 열 화상 카메라로 배터리 온도를 점검하십시오.



7. 침수 시

차체에 전압이 남아 있을 위험이 없습니다.

차량 구조 후:

1. 내부의 물을 배출시키십시오.
2. 고전압 시스템의 비활성화를 시작하십시오(3장 참조).



8. 견인/운송/보관

차량의 두 차축으로만 견인 트럭이나 자동차 운반 수단에 올려 운반하십시오.

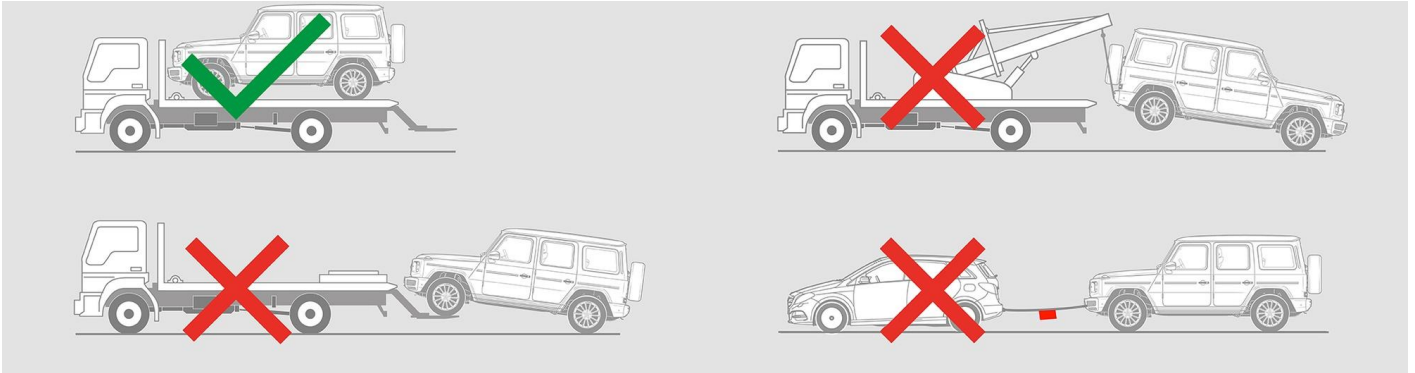

다른 차량과 안전한 거리를 유지하십시오.

 경고: 배터리의 재점화 

9. 중요 추가 정보

자세한 내용은 [견인 서비스 지침](#), [승용차](#) 에서 확인할 수 있습니다.

10. 사용된 픽토그램 설명

-  전기 자동차
-  위험
-  위험 전압
-  가연성
-  건강에 위험
-  부식성
-  만성 독성
-  폭발성
-  물로 끄기
-  IR 열영상 카메라 사용
-  엔진 후드
-  트렁크
-  스마트 키 제거
-  Air-conditioning component