

-  에어백
-  가스 발전기
-  안전벨트 텐서너
-  SRS 컨트롤 유닛
-  액티브 보행자 보호 시스템
-  가스 압력 댐퍼/프리텐션 스프링
-  안전 구역
-  저전압 배터리
-  휘발유 연료 탱크

참고 사항: 자세한 내용은 [구조 안내서](#) 참조.

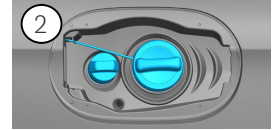

1. 식별/ 인식

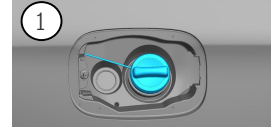

2. 고정 / 안정화 / 리프팅

주차 브레이크

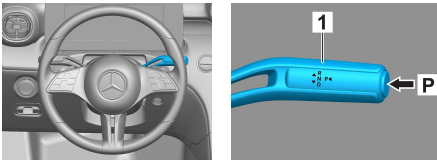

선택기 레버(1)의 스위치 P를 누르십시오. 주차 브레이크가 자동으로 활성화됩니다.

주차 브레이크

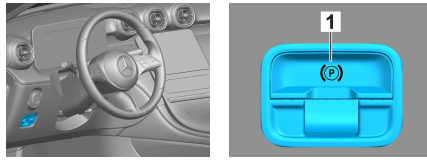

전자 주차 브레이크 (1)

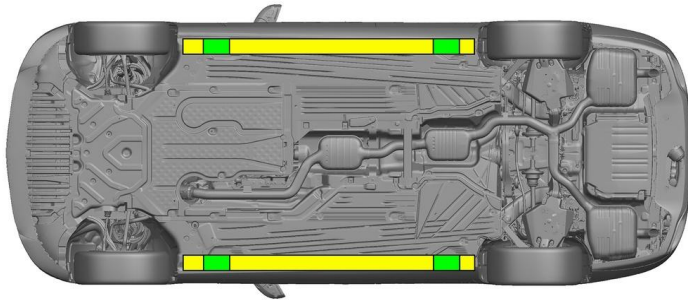

- 적합한 인양 지점
- 측면의 적합한 안정화 지점



구조하는 중 로커 패널과 언더바디의 추가적인 변형(예: 유압 장비로 지지)이 없도록 유의해야 합니다.

3. 직접적인 위험 제거 / 안전 규정 준수

점화 장치 끄기:

- 주 브레이크를 밟지 않은 상태에서 START-STOP 버튼을 누르십시오.
- 전자 차량 키를 5m 이상의 거리에 두십시오.



12V/48V 배터리 분리

- 엔진실에 있는 12/48V 배터리 커버를 제거하십시오.
- 12/48V 배터리의 음극 케이블을 볼트 체결부에서 툰 후 의도치 않게 접촉되지 않도록 보호하십시오.



12/48V 배터리 분리

- 트렁크에 있는 12/48V 배터리 커버를 제거하십시오.
- 12/48V 배터리의 음극 케이블을 볼트 체결부에서 툰 후 의도치 않게 접촉되지 않도록 보호하십시오.



수동 보안 시스템(에어백 및 안전벨트 텐서너)이 비활성화됩니다.



4. 요구조자(탑승자)에 접근

승객을 구조할 때 페이지 1의 정보에 따른 시트 안전 시스템의 부품(특히 폭발 요소)을 고려해야 합니다.

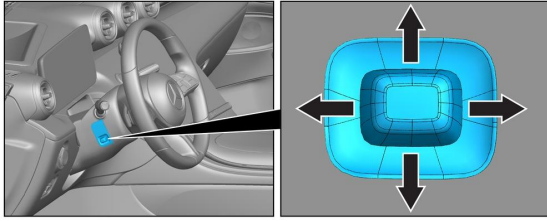

스티어링 휠 조정

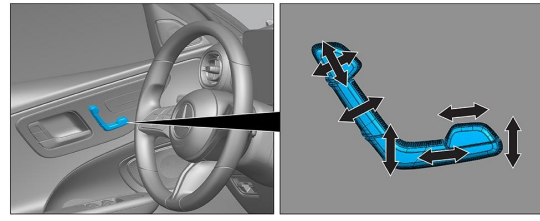

시트 조정(전동식)

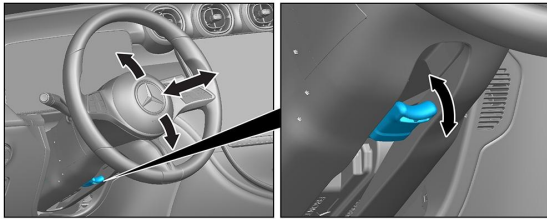

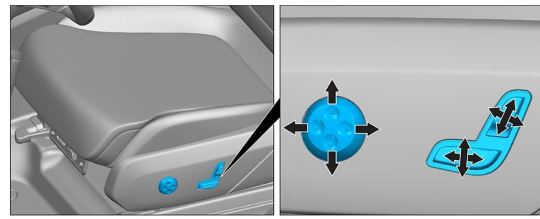

스티어링 휠 조정



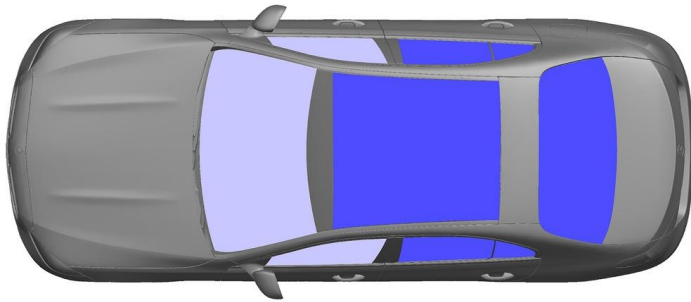













시트 조정(전동식)



 VSG: 접합안전유리

 ESG: 강화 안전 유리

5. 저장된 에너지/액체/가스/고체

	     	12/48V
	 	66L
	  	610 ± 10g

6. 화재 시



차량 화재를 진압하려면 다량의 물(H₂O)을 사용하십시오.

7. 침수 시

차체에 전압이 남아 있을 위험이 없습니다. 차량 구조 후:

1. 내부의 물을 배출시키십시오.
2. 12V/48V 차량 전원 시스템의 비활성화를 시작하십시오(3장 참조).



8. 견인/운송/보관

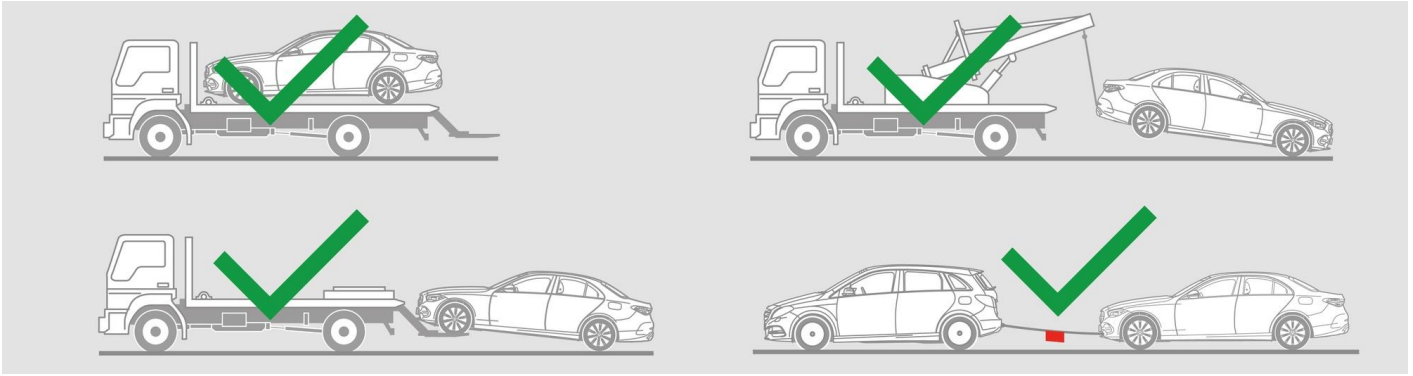

9. 중요 추가 정보

자세한 내용은 [견인 서비스 지침, 승용차](#) 에서 확인할 수 있습니다.

10. 사용된 픽토그램 설명

	차량, 1급 액체 연료 주입		차량, 2급 액체 연료 주입		위험		가연성
	건강에 위험		부식성		만성 독성		폭발성
	물로 끄기		드라이폼으로 끄기		젖 폼으로 끄기		엔진 후드
	트렁크		스마트 키 제거		Air-conditioning component		Warning: low temperature