

① 차량 전원 배터리

② 보조 배터리

③ 고전압 배터리

④ 고전압 충전 소켓



에어백

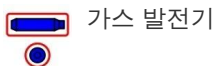

가스 발전기

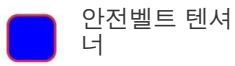

안전벨트 텐서너

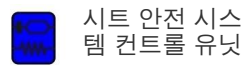

시트 안전 시스템 컨트롤 유닛



12V 배터리

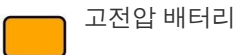

고전압 배터리

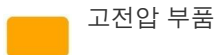

고전압 부품

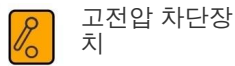

고전압 차단장치

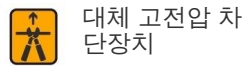

대체 고전압 차단장치

참고 사항: 자세한 내용은 [구조 안내서](#) 참조.



1. 식별/인식

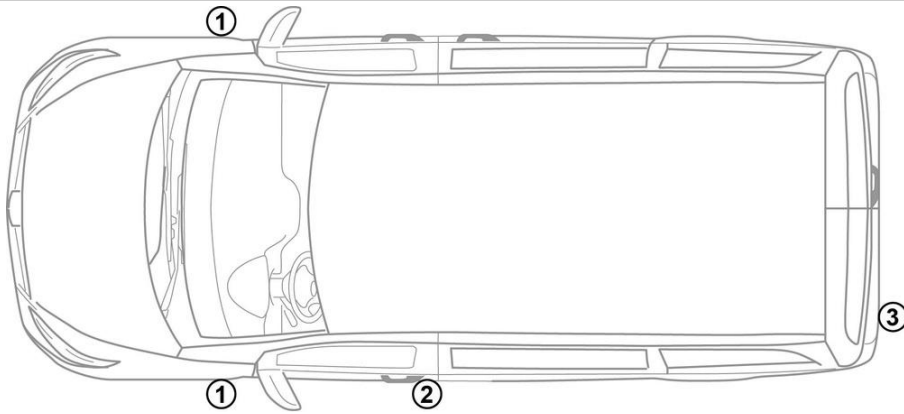

3. 직접적인 위험 제거 / 안전 규정 준수

고전압 시스템 비활성화

다른 모든 경우에는 다음과 같이 고전압 시스템을 비활성화해야 합니다.

옵션 1: 고압 분리 장치

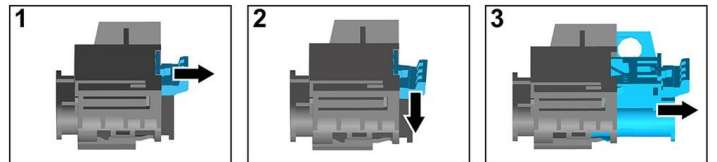
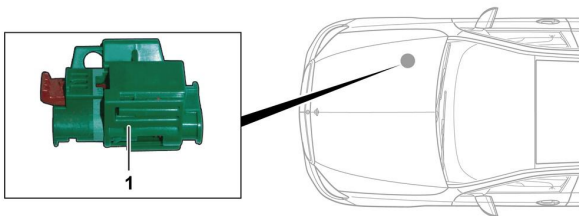

고전압 분리 장치는 동반석 측 엔진실에 있습니다.



- (1) 해제 레버 당기기
- (2) 해제 레버 아래로 누르기
- (3) 스위치 밖으로 빼내기

옵션 2: 대체 고압 분리 장치

대체 고전압 분리 장치는 우측 앞좌석의 시트 베이스에 있습니다. 이 장치는 정보 라벨로 표시되어 있습니다.

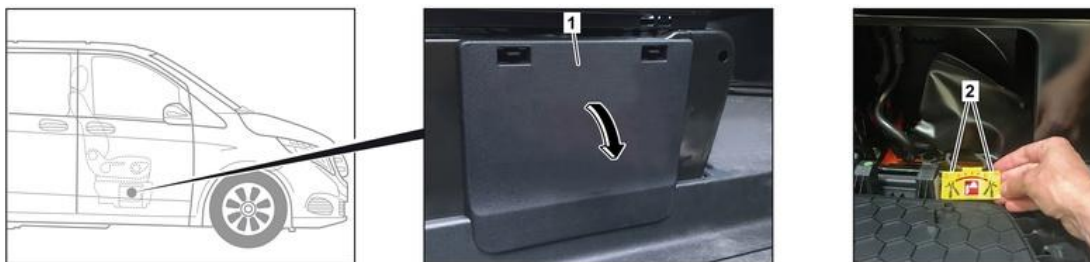

커버(1)를 제거하십시오. 표시된 지점(2)에서 라인을 절단하십시오.



12V 배터리 분리

- 1. 12V 배터리 커버 제거.
- 2. 12V 배터리의 음극 케이블을 볼트 체결부에서 푼 후 의도치 않게 접촉되지 않도록 보호하십시오.