

- |   |   |   |                    |   |  |   |                                  |   |                                     |
|---|---|---|--------------------|---|--|---|----------------------------------|---|-------------------------------------|
|  | Airbag  |  | Generatore di gas  |  | Pretensionatore delle cinture di sicurezza |  | Scheda elettronica SRS           |  | Sistema attivo di protezione pedoni |
|  | Ammortizzatore pneumatico / molla precaricata |  | Zona di attenzione |  | Batteria a basso voltaggio                 |  | Benzina serbatoio del carburante |   |                                     |

Nota: Ulteriori informazioni sono disponibili nelle nostre linee guida per il soccorso [linee guida per il soccorso](#)

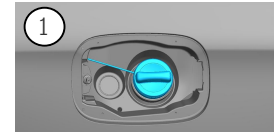

1. Identificazione / riconoscimento



2. Immobilizzazione / stabilizzazione / sollevamento

Freno di parcheggio



Freno di stazionamento

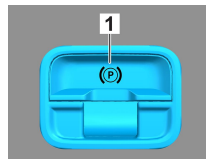

Premere il pulsante P sulla leva di selezione (1). Il freno di stazionamento elettrico (1) viene attivato automaticamente.

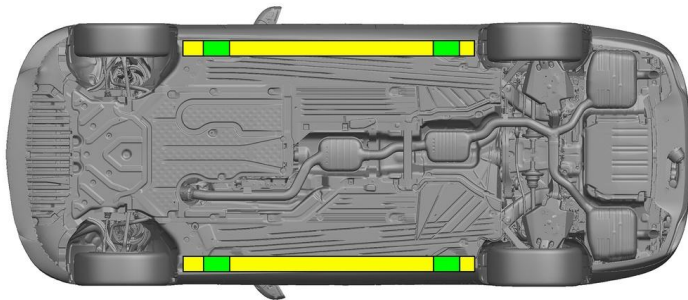

- Adeguati punti di sollevamento
- Adeguati punti di stabilizzazione sul lato

Evitare un'ulteriore deformazione della pedana e del sottoscocca durante il salvataggio (ad es. sollevamento con equipaggiamento idraulico).

3. Disattivazione dei pericoli diretti / Regolamenti di Sicurezza

Disinserire l'accensione:

1. Premere il tasto START-STOP senza azionare il freno di esercizio.
2. Tenere la chiave elettronica del veicolo a distanza di almeno 5 m.

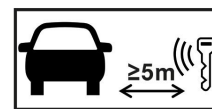

Distacco della batteria a 12 V/48 V

1. Rimuovere il coperchio della batteria a 12/48 Volt nel vano motore.
2. Scollegare il cavo negativo della batteria a 12/48 Volt nel raccordo a vite e metterlo in sicurezza contro un involontario contatto.



Scollegare la batteria a 12/48 V

1. Rimuovere il coperchio della batteria a 12/48 Volt nel bagagliaio.
2. Scollegare il cavo negativo della batteria a 12/48 Volt nel raccordo a vite e metterlo in sicurezza contro un involontario contatto.



I sistemi di sicurezza passivi (airbag e pretensionatori delle cinture di sicurezza) vengono disattivati.



### 4. Accesso agli occupanti

Nell'ambito della liberazione degli occupanti si deve tenere conto dei componenti dei sistemi di ritenuta (in particolare degli elementi pirotecnici) conformemente alle indicazioni fornite a pagina 1.

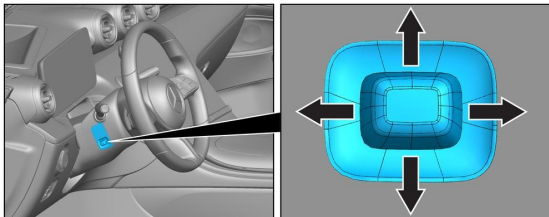

Regolazione del volante

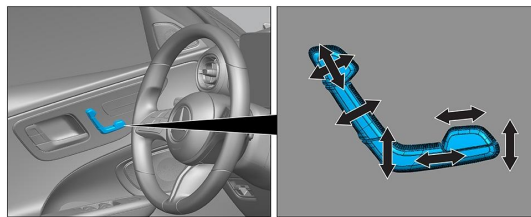

Regolazione (elettrica) del sedile

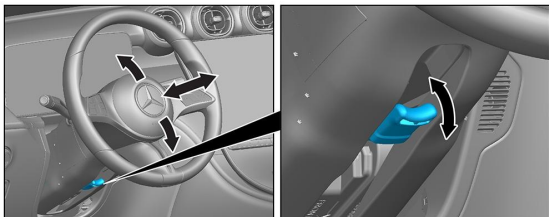

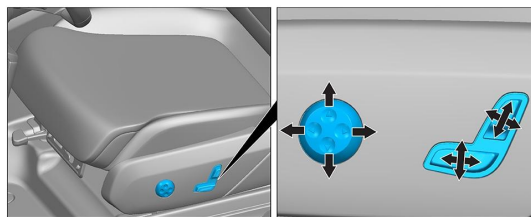

Regolazione del volante



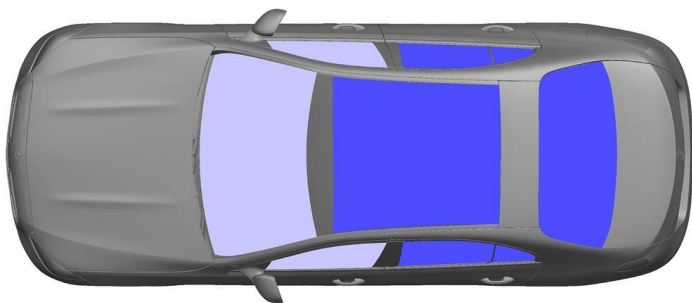











Regolazione (elettrica) del sedile



 VSG: Verbundsicherheitsglas, vetro stratificato di sicurezza

 ESG: vetro di sicurezza monostrato

### 5. Immagazzinamento energia / liquidi / gas / solidi

	    	12/48V
	 	66L
	  	610 ± 10g

### 6. In caso d'incendio



Per estinguere l'incendio di un veicolo utilizzare grandi quantità di acqua (H<sub>2</sub>O).

### 7. In caso di immersione

Non sussiste il pericolo di tensione sulla carrozzeria. Dopo il recupero del veicolo:

1. Fare defluire l'acqua dall'abitacolo.
2. Avviare la disattivazione della rete di bordo a 12/48 V (vedere il capitolo 3).



### 8. Traino / trasporto / stazionamento

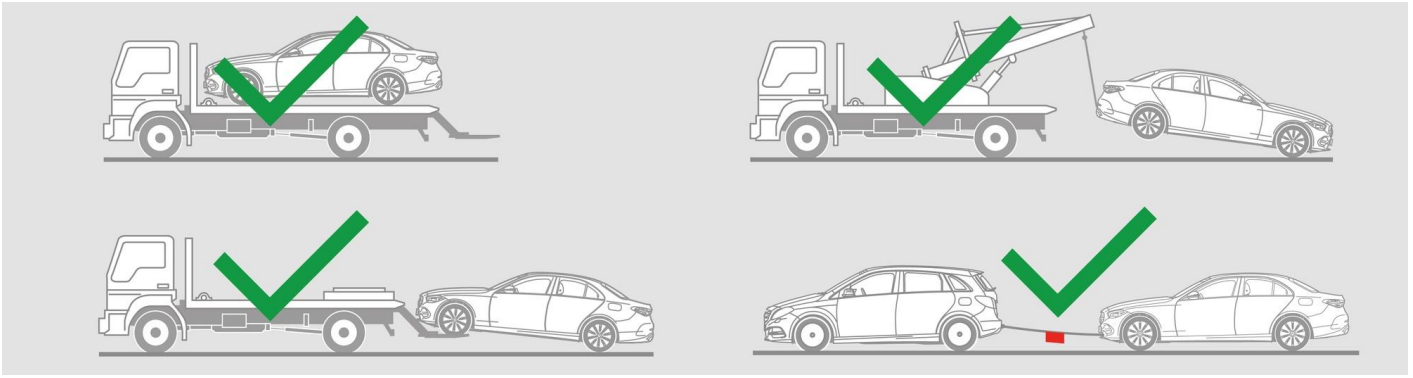

### 9. Informazioni aggiuntive importanti

Ulteriori informazioni sono riportate nelle [Linee guida per i servizi di traino Autovetture](#).

### 10. Spiegazione dei pittogrammi utilizzati

- |  |  |  |  |  |                               |  |  |
|--|--|--|--|--|-------------------------------|--|--|
|  | Veicolo con carburante del gruppo liquido 2        |  | Attenzione pericolo generico                       |  | Infiammabile                  |  | Pericoloso per la salute umana             |
|  | Corrosivi  |  | Tossicità acuta                                    |  | Esplosivo                     |  | Utilizzare l'acqua per spegnere l'incendio |
|  | Utilizzare schiuma a secco per spegnere l'incendio |  | Utilizzare schiuma bagnata per spegnere l'incendio |  | Cofano                        |  | Bagagliaio                                 |
|  | Rimozione chiave intelligente                      |  | Componente di aria condizionata                    |  | Attenzione; bassa temperatura |  |  |