

-  Airbag
-  Generatore di gas
-  Pretensionatore delle cinture di sicurezza
-  Scheda elettronica SRS
-  Sistema attivo di protezione pedoni
-  Ammortizzatore pneumatico / molla precaricata
-  Batteria a basso voltaggio
-  Benzina serbatoio del carburante
-  Cablaggi di alimentazione Alta tensione
-  Componente ad alta tensione
-  Taglio del cavo
-  Sezionatore a bassa tensione che scollega l'alta tensione

Nota: Ulteriori informazioni sono disponibili nelle nostre linee guida per il soccorso [linee guida per il soccorso](#)

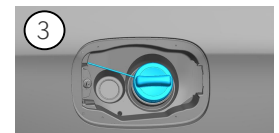

### 1. Identificazione / riconoscimento



### 2. Immobilizzazione / stabilizzazione / sollevamento

#### Freno di parcheggio

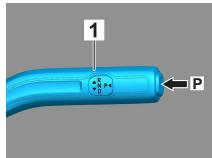
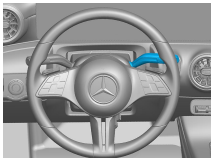

#### Freno di stazionamento

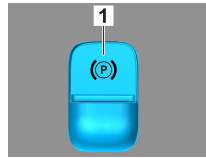
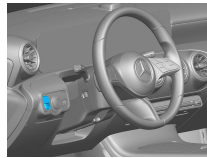

Premere il pulsante P sulla leva di selezione (1). Il freno di stazionamento elettrico (1) viene attivato automaticamente.

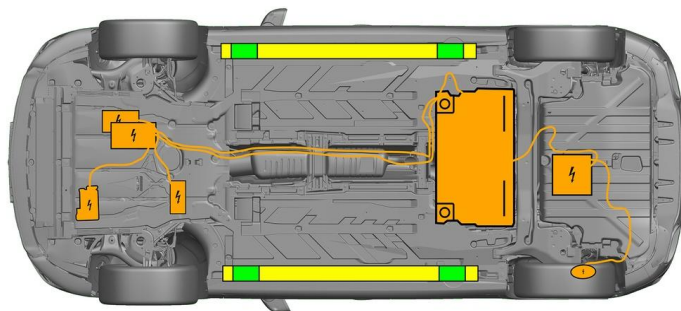

- Adeguati punti di sollevamento
- Adeguati punti di stabilizzazione sul lato
- Batteria ad alto voltaggio



Evitare un'ulteriore deformazione della pedana e del sottoscocca durante il salvataggio (ad es. sollevamento con equipaggiamento idraulico).

### 3. Disattivazione dei pericoli diretti / Regolamenti di Sicurezza

#### Disinserire l'accensione:

1. Premere il tasto START-STOP senza azionare il freno di esercizio.
2. Tenere la chiave elettronica del veicolo a distanza di almeno 5 m.

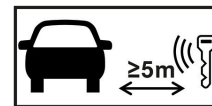

L'assenza di rumori dal motore non significa che il veicolo sia spento.



Un riavvio è possibile solo fino alla messa fuori servizio del veicolo.

#### Disattivazione del sistema ad alto voltaggio



In caso di incidenti con attivazione dell'airbag e dei pretensionatori delle cinture di sicurezza, il sistema ad alto voltaggio viene automaticamente disattivato.





In tutti gli altri casi disattivare il sistema ad alto voltaggio come indicato di seguito:

### Opzione 1: Dispositivo di disinserimento dell'alto voltaggio

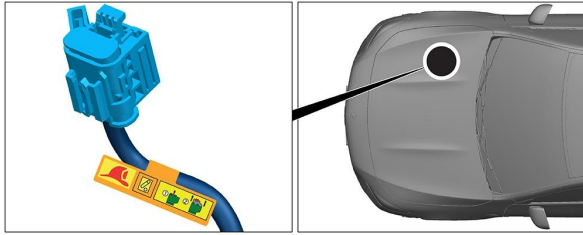

Il dispositivo di disinserimento dell'alto voltaggio si trova nel vano motore lato passeggero.



- (1) Tirare il dispositivo di sblocco
- (2) Premere verso il basso il dispositivo di sblocco
- (3) Estrarre il commutatore

### Opzione 2: Dispositivo alternativo di disinserimento dell'alto voltaggio



Il dispositivo alternativo di disinserimento dell'alto voltaggio si trova sotto il coperchio della scatola dei fusibili nel cockpit lato conducente. È contrassegnato con una targhetta.

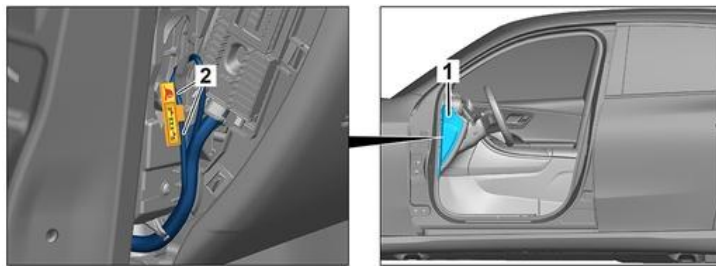

Rimuovere il coperchio (1). Tagliare il cavo nel punto marcato (2).



Per assicurare che nella rete dell'alta tensione non vi sia più tensione residua, dopo la disattivazione attendere circa 20 secondi.



I sistemi di sicurezza passivi, quali airbag e pretensionatori delle cinture di sicurezza, continuano a ricevere tensione tramite la rete di bordo a 12 volt.



#### Scollegare la batteria a 12 V

1. Rimuovere il coperchio della batteria a 12 Volt nel vano motore.
2. Scollegare il cavo negativo della batteria a 12 Volt nel raccordo a vite e metterlo in sicurezza contro un involontario contatto.



#### Scollegare la batteria a 12 V

1. Rimuovere il coperchio della batteria a 12 Volt.
2. Scollegare il cavo negativo della batteria a 12 Volt nel raccordo a vite e metterlo in sicurezza contro un involontario contatto.



I sistemi di sicurezza passivi (airbag e pretensionatori delle cinture di sicurezza) vengono disattivati.



### 4. Accesso agli occupanti

Nell'ambito della liberazione degli occupanti si deve tenere conto dei componenti dei sistemi di ritenuta (in particolare degli elementi pirotecnici) conformemente alle indicazioni fornite a pagina 1.



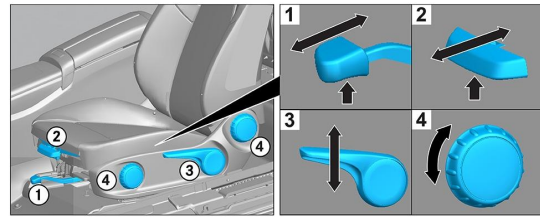

Regolazione del volante



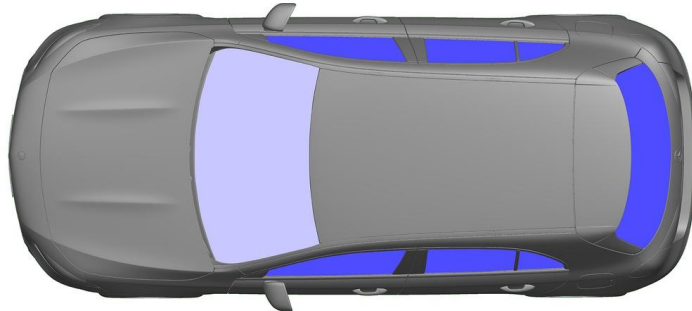

















Regolazione (meccanica) del sedile



 VSG: Verbundsicherheitsglas, vetro stratificato di sicurezza

 ESG: vetro di sicurezza monostrato

### 5. Immagazzinamento energia / liquidi / gas / solidi

	  	12V
	     	400V
	 	35L
	  	560 ± 10g



 Tutti i cavi ad alto voltaggio sono dotati di un isolamento di colore arancione.

### 6. In caso d'incendio



Per estinguere l'incendio di un veicolo utilizzare grandi quantità di acqua (H<sub>2</sub>O).  
Per raffreddare la batteria Li-Ion utilizzare grandi quantità di acqua (H<sub>2</sub>O).

 **Avviso: Riaccensione della batteria** 

 In caso di fuoriuscita di fluido refrigerante dalla batteria ad alto voltaggio, questa può diventare instabile a causa del sovraccarico termico. Controllare la temperatura della batteria con una termocamera a infrarossi. 

### 7. In caso di immersione

Non sussiste il pericolo di tensione sulla carrozzeria.

Dopo il recupero del veicolo:

1. Fare defluire l'acqua dall'abitacolo.
2. Avviare la disattivazione del sistema ad alto voltaggio (vedere il capitolo 3).



### 8. Traino / trasporto / stazionamento

Effettuare il trasporto del veicolo solo a condizione che entrambi gli assi siano posizionati su un carro attrezzi o su un autocarro per il trasporto di autoveicoli.

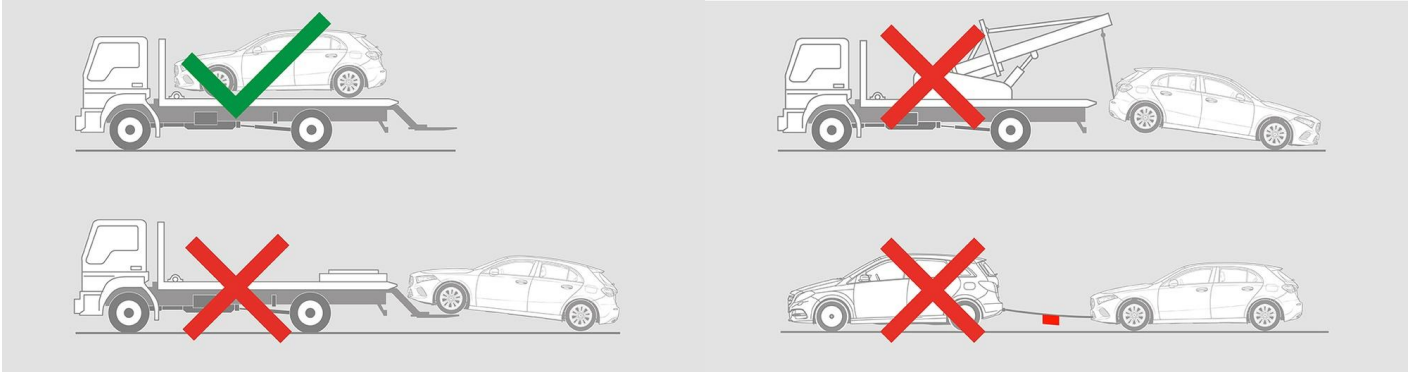











Stazionare il veicolo a distanza di sicurezza da altri veicoli.

 **Avviso: Riaccensione della batteria** 

### 9. Informazioni aggiuntive importanti

Ulteriori informazioni sono riportate nelle [Linee guida per i servizi di traino Autovetture](#).

### 10. Spiegazione dei pittogrammi utilizzati

	Veicolo elettrico ibrido con carburante del gruppo liquido 2 (benzina, etanolo)		Attenzione pericolo generico		Attenzione, elettricità		Infiammabile
	Pericoloso per la salute umana		Corrosivi		Tossicità acuta		Esplosivo
	Utilizzare l'acqua per spegnere l'incendio		Utilizzare la termocamera ad infrarossi		Cofano		Rimozione chiave intelligente
	Componente di aria condizionata		Attenzione; bassa temperatura				