





- | | | | | | | | | | |
|---|--------------------------|---|--------------------------|---|----------------------------|---|------------------------|---|--|
|  | Zračni jastuk |  | Plinski generator |  | Zatezač sigurnosnog pojasa |  | SRS upravljački uređaj |  | Plinsko-hidraulični podupirač / zategnuta opruga |
|  | Niskonaponski akumulator |  | Dizel spremnik za gorivo | | | | | | |

Napomena: Dodatne informacije potražite u našem [Vodiču za spašavanje](#).



1. Identifikacija

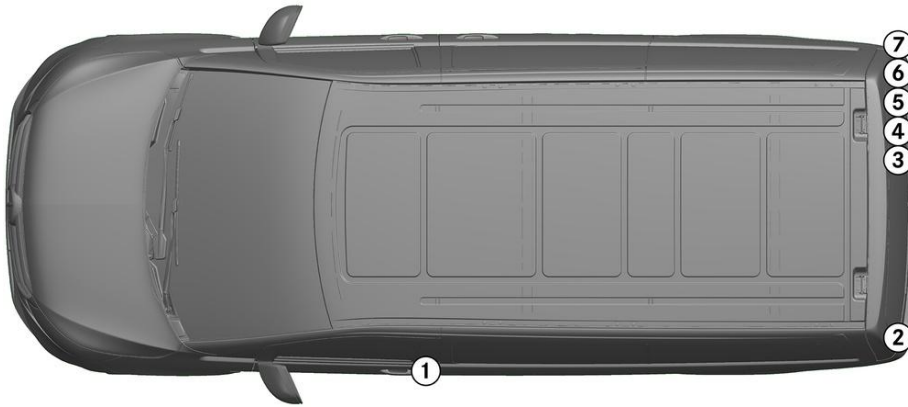

2
VITO

3
110 CDI

4
114 CDI

5
116 CDI

6
119 CDI

7
124 CDI

2. Imobilizacija / stabilizacija / dizanje

Elektronička parkirna kočnica

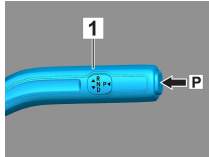
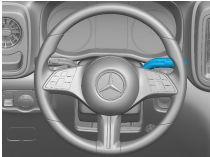

Mehanička parkirna kočnica

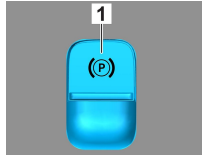

Pritisnite ručicu mjenjača (1) u položaj P. Automatski se aktivira elektronička parkirna kočnica.

Električna parkirna kočnica (1)

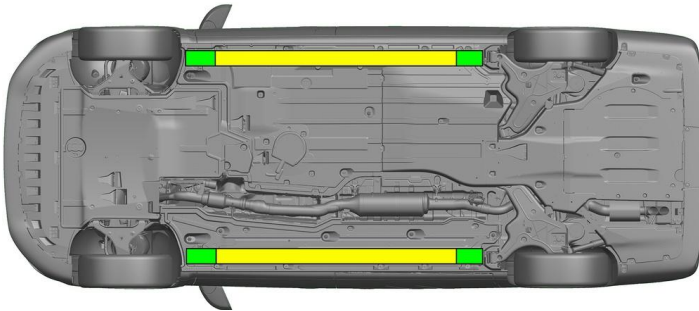

Prikladne podizne točke



Prikladne stabilizacijske točke na bočnoj strani



Morate izbjeći dodatno izobličenje pragova i podvozja tijekom spašavanja (npr. podupiranjem hidrauličkom opremom).

3. Sigurnosni propisi / izključivanje opasnosti

Isključivanje paljenja:

1. Pritisnite tipku za pokretanje/zaustavljanje bez aktivacije pogonske kočnice.
2. Pohanite elektronički ključ vozila na udaljenosti od najmanje 5 m.



Samo zato što ne čujete zvukove motora, ne znači da je vozilo isključeno.



Vozilo je moguće ponovo pokrenuti dok ga ne stavite izvan pogona.



Odvajanje akumulatora od 12 V

1. Uklonite pokrov akumulatora od 12 V
2. Otpustite minus kabel akumulatora od 12 V na vijčanom spoju i osigurajte ga od neželjenog kontakta.



Deaktiviraju se pasivni sigurnosni sustavi (zračni jastuci i zatezači sigurnosnih pojaseva).

4. Pristup putnicima

Tijekom oslobađanja putnika potrebno je obratiti pozornost na komponente zaštitnog sustava (posebice pirotehničke elemente) u skladu s informacijama na stranici 1.

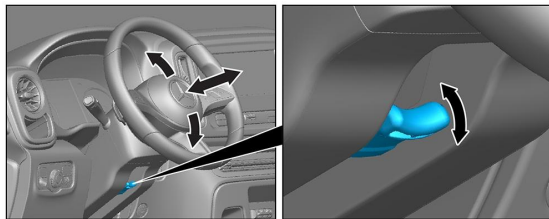

Podešavanje upravljača

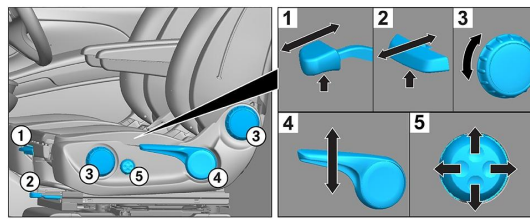

Podešavanje sjedala (električki)



 VSG: višeslojno zaštitno staklo

 ESG: kaljeno staklo

5. Spremljena energija / tekućine / plinovi / kruta goriva

	  	12 V
	 	70 L
	  	600 ± 10 g

6. U slučaju požara



Požar vozila ugasite velikom količinom vode (H₂O).

7. U slučaju uranjanja

Ne postoji opći znak upozorenja da je karoserija pod naponom. Nakon spašavanja vozila:

1. Pustite da voda izađe iz unutrašnjosti vozila.
2. Deaktivirajte unutarnju naponsku mrežu od 12 V / 48 V (vidi 3. poglavlje).



8. Transport / skladištenje / odvuci

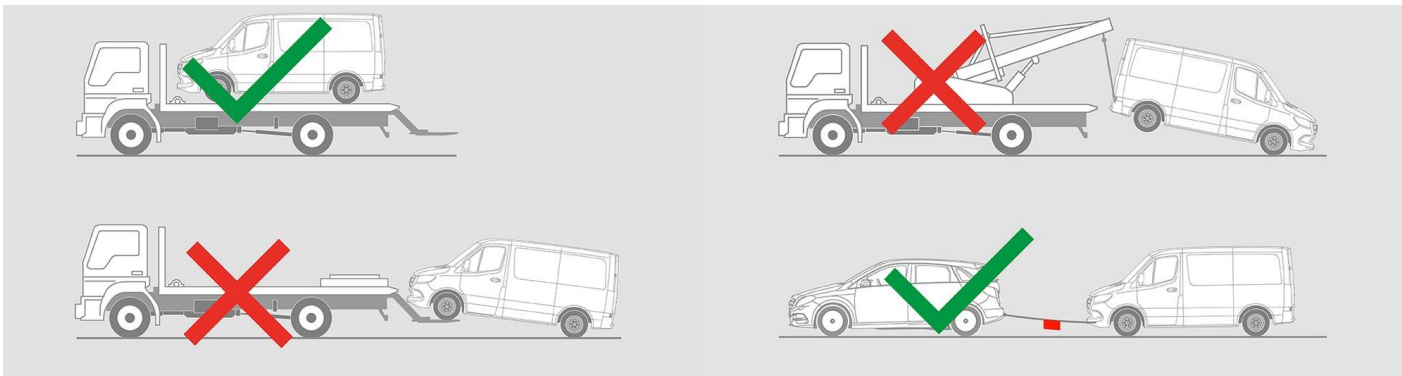

9. Vazne dodatne informacije

Dodatne informacije potražite u [Vodiču za službu za vuču osobnih motornih vozila](#).

10. Objasnjenje piktograma

	Vozilo na gorivo skupine tekućina 1		Opći znak upozorenja		Zapaljivo		Opasno za ljudsko zdravlje
	Korozivna tvar		Eksplziv		Uporaba vode prilikom gašenja požara		Uporaba suhe pjene za gašenje požara
	Uporaba vlažne pjene za gašenje požara		Uklanjanje pametnog ključa		Komponenta klima-uređaja		Upozorenje, niska temperatura