

- | | | | | |
|--|--|--|--|--|
|  Zračni jastuk |  Plinski generator |  Zatezač sigurnosnog pojasa |  SRS upravljački uređaj |  Sustav aktivne zaštite pješaka |
|  Plinsko-hidraulični podupirač / zategnuta opruga |  Niskonaponski akumulator |  Dizel spremnik za gorivo | | |



1. Identifikacija



②

CLA 220d

③

4MATIC

2. Imobilizacija / stabilizacija / dizanje

Elektronička parkirna kočnica

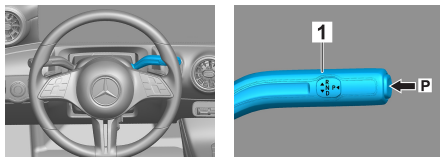

Pritisnite sklopku P na ručici mjenjača (1).
Automatski se aktivira elektronička parkirna
kočnica.

Mehanička parkirna kočnica



Električna parkirna kočnica (1)

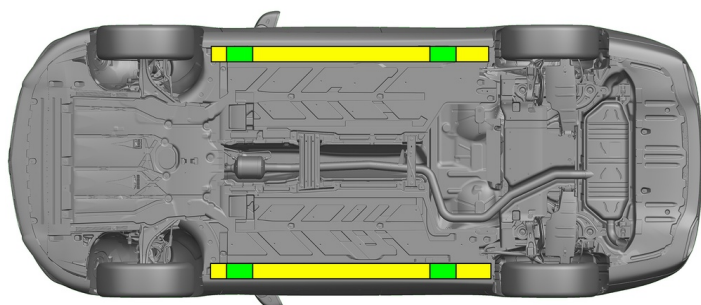

Prikladne podizne točke



Prikladne stabilizacijske točke na bočnoj strani



Morate izbjeći dodatno izobličenje pragova i podvozja tijekom spašavanja (npr. podupiranjem hidrauličkom opremom).

3. Sigurnosni propisi / izključivanje opasnosti

Isključivanje paljenja:

1. Pritisnite tipku za pokretanje/zaustavljanje bez aktivacije pogonske kočnice.
2. Pohranite elektronički ključ vozila na udaljenosti od najmanje 5 m.

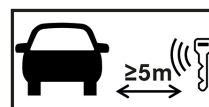

Samo zato što ne čujete zvukove motora, ne znači da je
vozilo isključeno.



Vozilo je moguće ponovo pokrenuti dok ga ne stavite
izvan pogona.



Odvajanje akumulatora od 12 V

1. Uklonite pokrov akumulatora od 12 V u prostoru motora.
2. Otpustite minus kabel akumulatora od 12 V na vijčanom spoju i osigurajte ga od neželjenog kontakta.





Odvajanje akumulatora od 12 V

1. Uklonite pokrov akumulatora od 12 V
2. Otpustite minus kabel akumulatora od 12 V na vijčanom spoju i osigurajte ga od neželjenog kontakta.



Deaktiviraju se pasivni sigurnosni sustavi (zračni jastuci i zatezači sigurnosnih pojaseva).

4. Pristup putnicima

Tijekom oslobađanja putnika potrebno je obratiti pozornost na komponente zaštitnog sustava (posebice pirotehničke elemente) u skladu s informacijama na stranici 1.

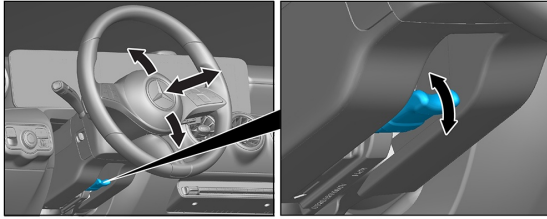

Podešavanje upravljača

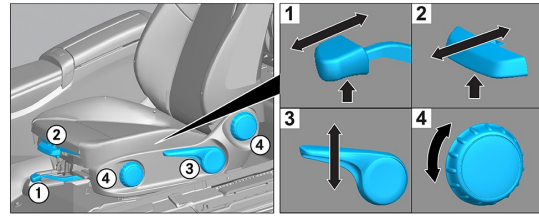

Podešavanje sjedala (mehanički)

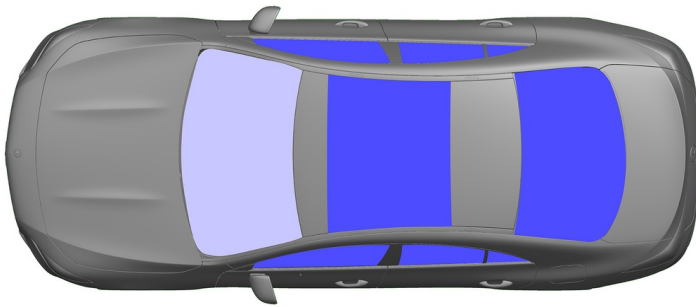

- VSG: višeslojno zaštitno staklo
- ESG: kaljeno staklo

5. Spremljena energija / tekućine / plinovi / kruta goriva

		12 V
		43 L
		590 ± 10 g

6. U slučaju požara



Požar vozila ugasite velikom količinom vode (H₂O).

7. U slučaju uranjanja

Ne postoji opći znak upozorenja da je karoserija pod naponom. Nakon spašavanja vozila:

1. Pustite da voda izađe iz unutrašnjosti vozila.
2. Deaktivirajte unutarnju naponsku mrežu od 12 V / 48 V (vidi 3. poglavlje).



8. Transport / skladištenje / odvuci

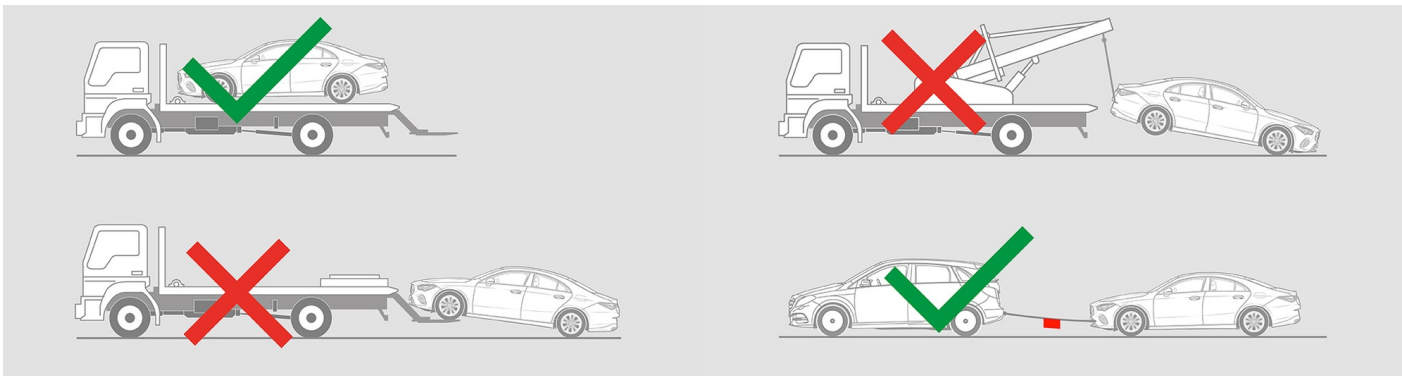

9. Vazne dodatne informacije

Dodatne informacije potražite u [Vodiču za službu za vuču osobnih motornih vozila](#).

Napomena: Dodatne informacije potražite u našem [Vodiču za spašavanje](#).

10. Objasnjenje piktograma

- | | | | | | | | |
|--|--|--|----------------------|--|--------------------------------------|--|--------------------------------------|
| | Vozilo na gorivo skupine tekućina 1 | | Opći znak upozorenja | | Zapaljivo | | Opasno za ljudsko zdravlje |
| | Korozivna tvar | | Eksploziv | | Uporaba vode prilikom gašenja požara | | Uporaba suhe pjene za gašenje požara |
| | Uporaba vlažne pjene za gašenje požara | | Poklopac motora | | Uklanjanje pametnog ključa | | Komponenta klima-uređaja |
| | Upozorenje, niska temperatura | | | | | | |