











-  Zračni jastuk
-  Plinski generator
-  Zatezač sigurnosnog pojasa
-  SRS upravljački uređaj
-  Sustav aktivne zaštite pješaka
-  Plinsko-hidraulični podupirač / zategnuta opruga
-  Niskonaponski akumulator
-  Benzin spremnik za gorivo
-  Visokonaponski akumulatorski paket
-  Visokonaponski električni kabel
-  Visokonaponska komponenta
-  Prekid kabela
-  Niskonaponski uređaj koji isključuje visoki napon

Napomena: Dodatne informacije potražite u našem [Vodiču za spašavanje](#).



1. Identifikacija



2

A 250e

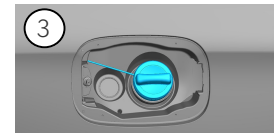

2. Imobilizacija / stabilizacija / dizanje

Elektronička parkirna kočnica

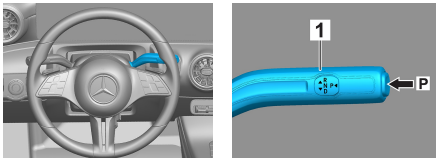

Mehanička parkirna kočnica



Pritisnite sklopku P na ručici mjenjača (1). Automatski se aktivira elektronička parkirna kočnica.

Električna parkirna kočnica (1)

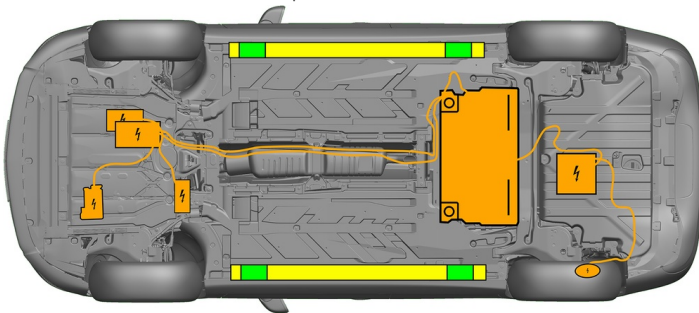

- Prikladne podizne točke
- Prikladne stabilizacijske točke na bočnoj strani
- Visokonaponski akumulator



Morate izbjeći dodatno izobličenje pragova i podvozja tijekom spašavanja (npr. podupiranjem hidrauličkom opremom).

3. Sigurnosni propisi / izključivanje opasnosti

Isključivanje paljenja:

1. Pritisnite tipku za pokretanje/zaustavljanje bez aktivacije pogonske kočnice.
2. Pohranite elektronički ključ vozila na udaljenosti od najmanje 5 m.

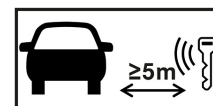

Samo zato što ne čujete zvukove motora, ne znači da je vozilo isključeno.



Vozilo je moguće ponovo pokrenuti dok ga ne stavite izvan pogona.

Deaktivacija visokonaponskog sustava



Visokonaponski sustav automatski se isključuje u slučaju nesreća kad se aktiviraju zračni jastuci ili zatezači sigurnosnih pojaseva.





U svim drugim slučajevima deaktivirajte visokonaponski sustav kako slijedi:



Mogućnost 1: Naprava za isključivanje visokog napona

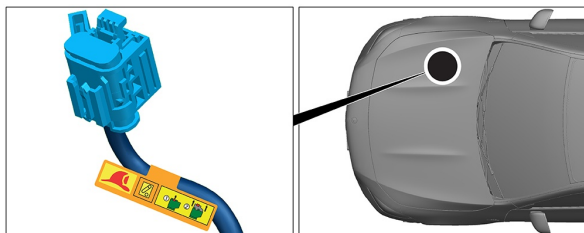

Naprava za isključivanje visokog napona nalazi se u prostoru motora na suvozačevoj strani.

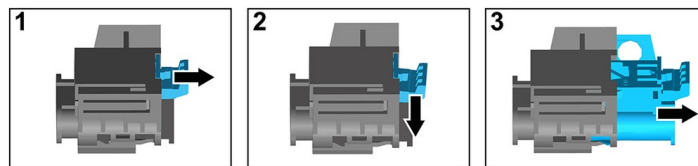

- (1) Povucite deblokadu
- (2) Pritisnite deblokadu prema dolje
- (3) Izvucite sklopku



Mogućnost 2: Alternativna naprava za isključivanje visokog napona

Alternativna naprava za isključivanje visokog napona nalazi se ispod pokrova kutije s osiguračima na kokpitu na vozačevoj strani. Označena je natpisom.

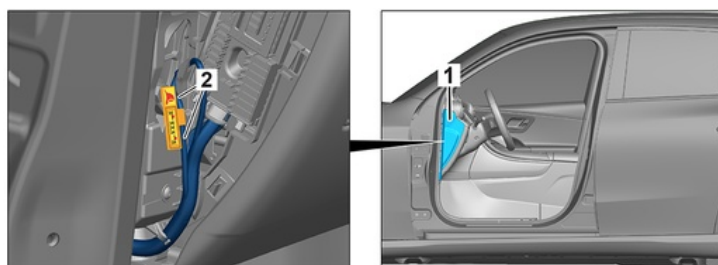

Uklonite pokrov (1). Prerežite vod na označenom mjestu (2).



Da biste osigurali da u visokonaponskoj mreži više nema preostalog napona, pričekajte cca 20 sekundi nakon isključivanja.



Unutarnja naponska mreža od 12 V i dalje naponom napaja pasivne sigurnosne sustave kao što su zračni jastuci i zatezači sigurnosnih pojaseva.



Odvajanje akumulatora od 12 V

1. Uklonite pokrov akumulatora od 12 V u prostoru motora.
2. Otpustite minus kabel akumulatora od 12 V na vijčanom spoju i osigurajte ga od neželjenog kontakta.



Odvajanje akumulatora od 12 V

1. Uklonite pokrov akumulatora od 12 V
2. Otpustite minus kabel akumulatora od 12 V na vijčanom spoju i osigurajte ga od neželjenog kontakta.



Deaktiviraju se pasivni sigurnosni sustavi (zračni jastuci i zatezači sigurnosnih pojaseva).

4. Pristup putnicima

Tijekom oslobađanja putnika potrebno je obratiti pozornost na komponente zaštitnog sustava (posebice pirotehničke elemente) u skladu s informacijama na stranici 1.

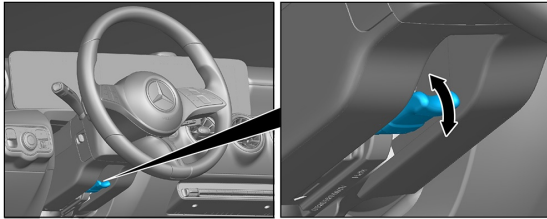

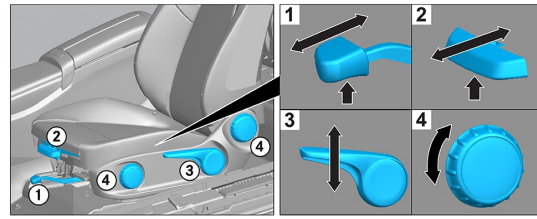

Podešavanje upravljača



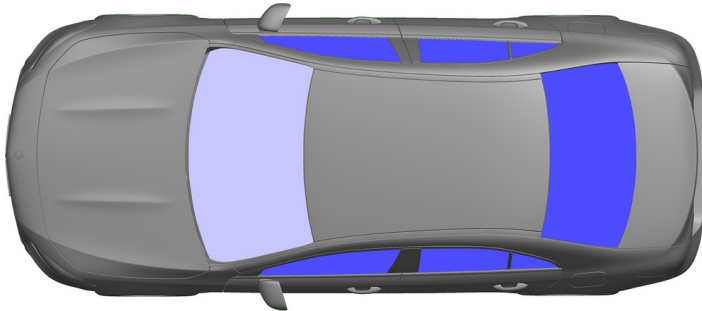

















Podešavanje sjedala (mehanički)



 VSG: višeslojno zaštitno staklo

 ESG: kaljeno staklo

5. Spremljena energija / tekucine / plinovi / kruta goriva

	  	12 V
	     	400 V
	 	35 L
	  	560 ± 10 g



Svi visokonaponski vodovi imaju narančastu izolaciju.

6. U slučaju požara



Požar vozila ugasite velikom količinom vode (H₂O).
Ohladite litij-ionski akumulator većom količinom vode (H₂O).



Upozorenje: Moguće paljenje baterije



Ako iz visokonaponskog akumulatora istječe rashladno sredstvo, akumulator može postati nestabilan uslijed toplinskog preopterećenja. Provjerite temperaturu akumulatora infracrvenom toplinskom kamerom.



7. U slučaju uranjanja

Ne postoji opći znak upozorenja da je karoserija pod naponom.

Nakon spašavanja vozila:

1. Pustite da voda izađe iz unutrašnjosti vozila.
2. Deaktivirajte visokonaponski sustav (vidi 3. poglavlje).



8. Transport / skladištenje / odvuci

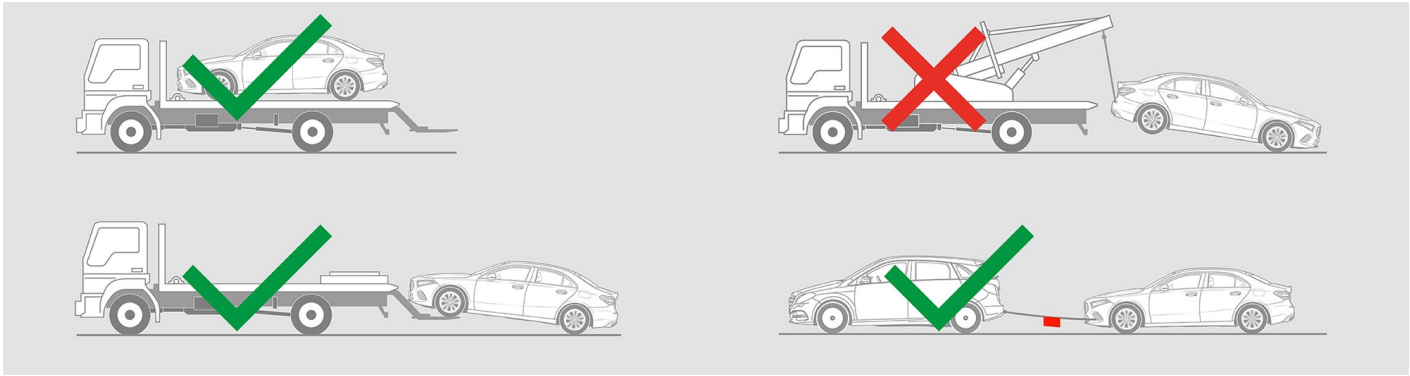









Pohranite ga na sigurnoj udaljenosti od drugih vozila.

 **Upozorenje: Moguće paljenje baterije** 

9. Vazne dodatne informacije

Dodatne informacije potražite u [Vodiču za službu za vuču osobnih motornih vozila](#).

10. Objasnjenje piktograma

 Hibridno električno vozilo na gorivo skupine tekućina 2	 Opći znak upozorenja	 Upozorenje, elektrika	 Zapaljivo
 Opasno za ljudsko zdravlje	 Korozivna tvar	 Akutna toksičnost	 Eksploziv
 Uporaba vode prilikom gašenja požara	 Uporaba toplinske infracrvene kamere	 Poklopac motora	 Uklanjanje pametnog ključa
 Komponenta klima-uređaja	 Upozorenje, niska temperatura		