







- | | | | | |
|---|---|--|--|--|
|  Zračni jastuk |  Plinski generator |  Zatezač sigurnosnog pojasa |  SRS upravljački uređaj |  Plinsko-hidraulični podupirač / zategnuta opruga |
|  Niskonaponski akumulator |  Benzin spremnik za gorivo | | | |

Napomena: Dodatne informacije potražite u našem [Vodiču za spašavanje](#).



1. Identifikacija



2. Imobilizacija / stabilizacija / dizanje

Elektronička parkirna kočnica

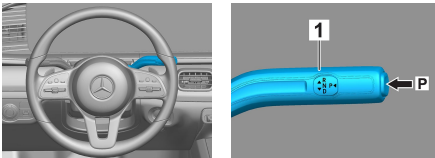

Mehanička parkirna kočnica

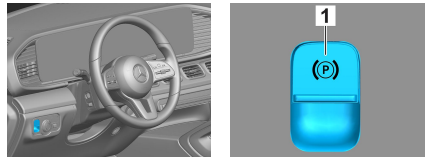

Pritisnite sklopku P na ručici mjenjača (1). Automatski se aktivira elektronička parkirna kočnica.

Električna parkirna kočnica (1)

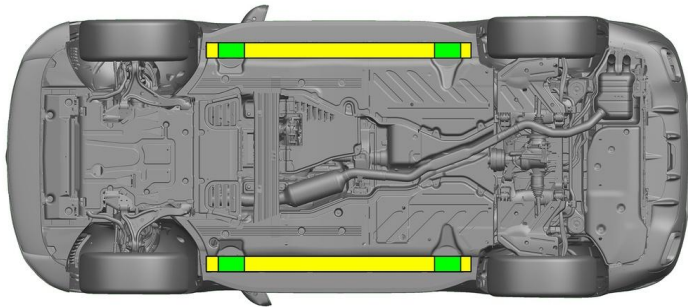

- Prikladne podizne točke
- Prikladne stabilizacijske točke na bočnoj strani



Morate izbjeći dodatno izobličenje pragova i podvozja tijekom spašavanja (npr. podupiranjem hidrauličkom opremom).

3. Sigurnosni propisi / izključivanje opasnosti

Isključivanje paljenja:

1. Pritisnite tipku za pokretanje/zaustavljanje bez aktivacije pogonske kočnice.
2. Pohranite elektronički ključ vozila na udaljenosti od najmanje 5 m.



Samo zato što ne čujete zvukove motora, ne znači da je vozilo isključeno.



Vozilo je moguće ponovo pokrenuti dok ga ne stavite izvan pogona.



Odvajanje akumulatora od 12 V / 48 V

1. Uklonite pokrov akumulatora od 12 V / 48 V
2. Otpustite minus kabel akumulatora od 12 V / 48 V na vijčanom spoju i osigurajte ga od neželjenog kontakta.



Deaktiviraju se pasivni sigurnosni sustavi (zračni jastuci i zatezači sigurnosnih pojaseva).



4. Pristup putnicima

Tijekom oslobađanja putnika potrebno je obratiti pozornost na komponente zaštitnog sustava (posebice pirotehničke elemente) u skladu s informacijama na stranici 1.



Podešavanje upravljača

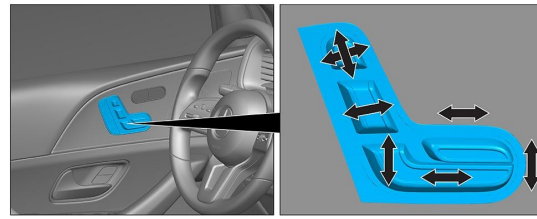

Podešavanje sjedala (električki)

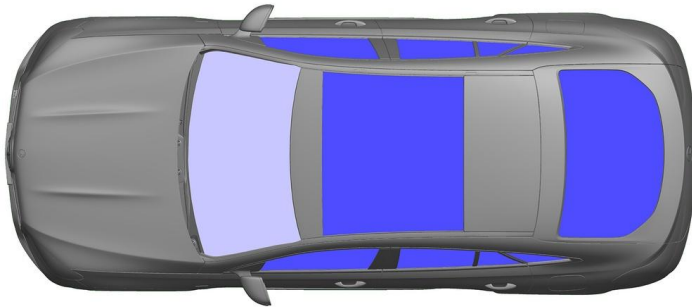

VSG: višeslojno zaštitno staklo
ESG: kaljeno staklo

5. Spremljena energija / tekućine / plinovi / kruta goriva

		12 V / 48 V
		85 L
		660 ± 10 g

6. U slučaju požara



Požar vozila ugasite velikom količinom vode (H₂O).

7. U slučaju uranjanja

Ne postoji opći znak upozorenja da je karoserija pod naponom. Nakon spašavanja vozila:

1. Pustite da voda izađe iz unutrašnjosti vozila.
2. Deaktivirajte unutarnju naponsku mrežu od 12 V / 48 V (vidi 3. poglavlje).

8. Transport / skladištenje / odvuci

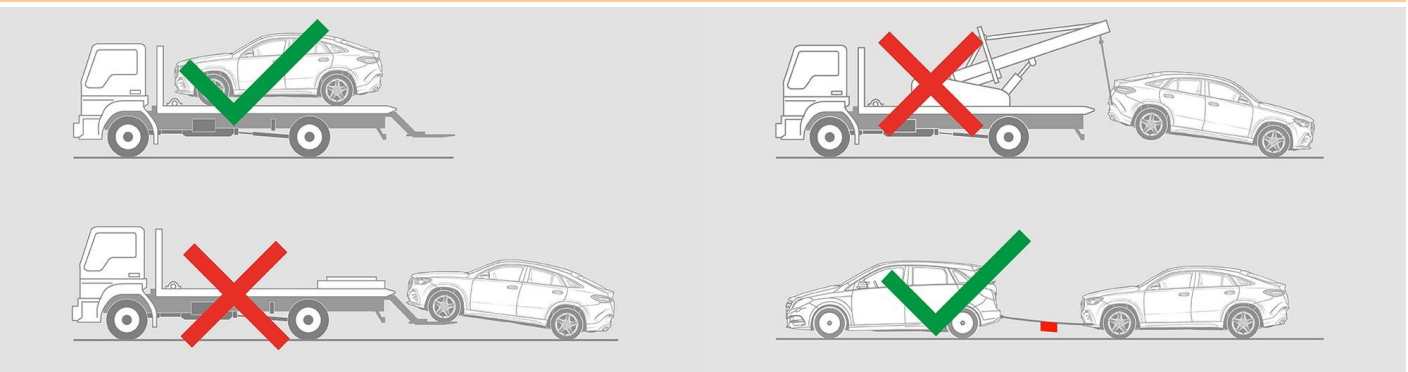



9. Vazne dodatne informacije

Dodatne informacije potražite u [Vodiču za službu za vuču osobnih motornih vozila](#).

10. Objasnjenje piktograma



Vozilo na gorivo skupine tekućina 2



Opći znak upozorenja



Zapaljivo



Opasno za ljudsko zdravlje



Korozivna tvar



Akutna toksičnost



Eksploziv



Uporaba vode prilikom gašenja požara



Uporaba suhe pjene za gašenje požara



Uporaba vlažne pjene za gašenje požara



Uklanjanje pametnog ključa



Komponenta klima-uređaja



Upozorenje, niska temperatura