











-  Zračni jastuk
-  Plinski generator
-  Zatezač sigurnosnog pojasa
-  SRS upravljački uređaj
-  Plinsko-hidraulični podupirač / zategnuta opruga
-  Zona opreza
-  Niskonaponski akumulator
-  Visokonaponski akumulatorski paket
-  Visokonaponski električni kabel
-  Visokonaponska komponenta
-  Visokonaponski uređaj koji isključuje visoki napon

Napomena: Dodatne informacije potražite u našem [Vodiču za spašavanje](#).



1. Identifikacija

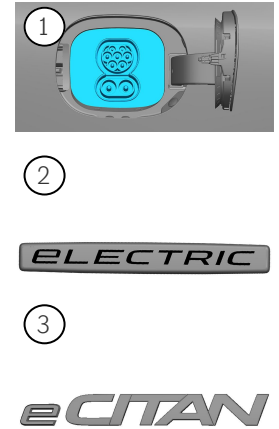
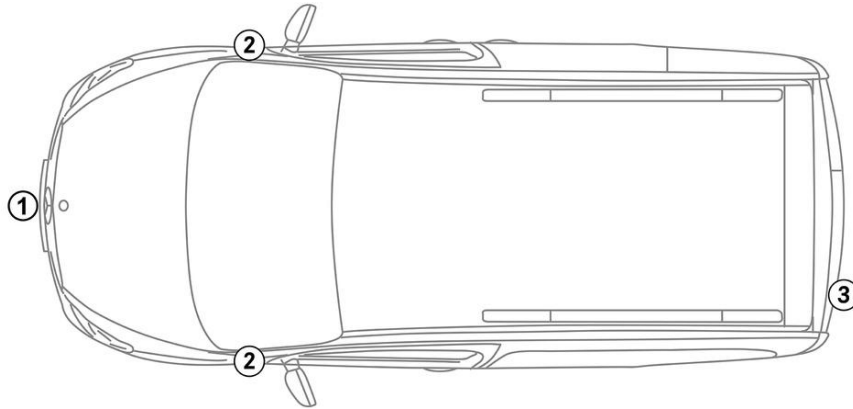

2. Imobilizacija / stabilizacija / dizanje

Elektronička parkirna kočnica



1. Pritisnite ručicu mjenjača u položaj P.

Mehanička parkirna kočnica

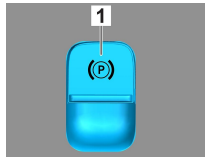

1. Električna parkirna kočnica

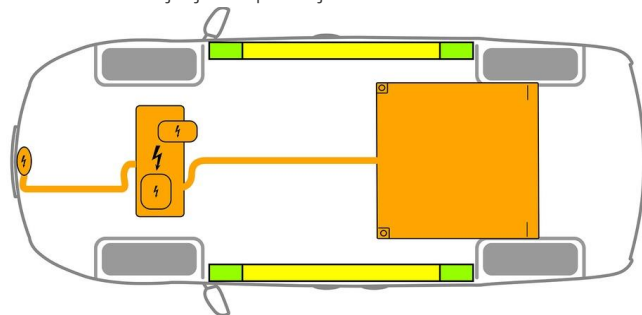

- Prikladne podizne točke
- Prikladne stabilizacijske točke na bočnoj strani
- Visokonaponski akumulator



Morate izbjeći dodatno izobličenje pragova i podvozja tijekom spašavanja (npr. podupiranjem hidrauličkom opremom).

3. Sigurnosni propisi / izključivanje opasnosti

Isključivanje paljenja:

1. Pritisnite tipku za pokretanje/zaustavljanje bez aktivacije pogonske kočnice.
2. Pohranite elektronički ključ vozila na udaljenosti od najmanje 5 m.

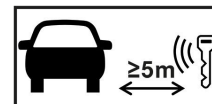

Samo zato što ne čujete zvukove motora, ne znači da je vozilo isključeno.



Vozilo je moguće ponovo pokrenuti dok ga ne stavite izvan pogona.

Deaktivacija visokonaponskog sustava



Visokonaponski sustav automatski se isključuje u slučaju nesreća kad se aktiviraju zračni jastuci ili zatezači sigurnosnih pojaseva.





U svim drugim slučajevima deaktivirajte visokonaponski sustav kako slijedi:



Mogućnost 1: Naprava za isključivanje visokog napona

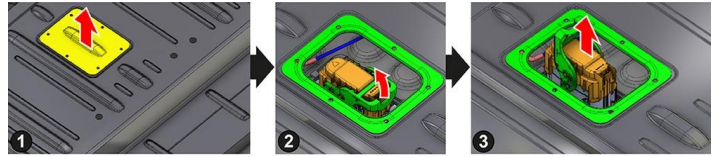
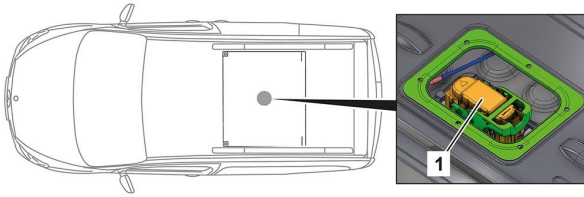

Uređaj za isključivanje visokonaponske električne mreže nalazi se u prostoru motora na vozačevoj strani.

Pomaknite stražnju klupu prema naprijed i podignite je.

Uređaj za isključivanje visokonaponske električne mreže nalazi se u unutrašnjosti na gornjoj strani visokonaponskog akumulatora.

(1) Uklonite zaštitnu kapicu i zaklopku.

(2) Otključajte utikač.

(3) Izvucite utikač.



Da biste osigurali da u visokonaponskoj mreži više nema preostalog napona, pričekajte cca 20 sekundi nakon isključivanja.



Unutarnja naponska mreža od 12 V i dalje naponom napaja pasivne sigurnosne sustave kao što su zračni jastuci i zatezači sigurnosnih pojaseva.



Odvajanje akumulatora od 12 V



1. Uklonite pokrov akumulatora od 12 V u prostoru motora.

2. Otpustite minus kabel akumulatora od 12 V na vijčanom spoju i osigurajte ga od neželjenog kontakta.



Deaktiviraju se pasivni sigurnosni sustavi (zračni jastuci i zatezači sigurnosnih pojaseva).

4. Pristup putnicima

Tijekom oslobađanja putnika potrebno je obratiti pozornost na komponente zaštitnog sustava (posebice pirotehničke elemente) u skladu s informacijama na stranici 1.

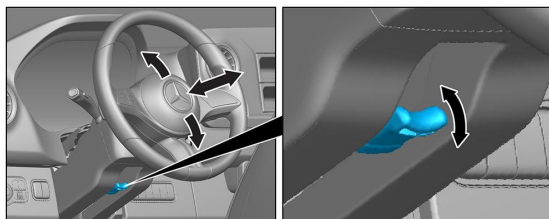

Podešavanje upravljača

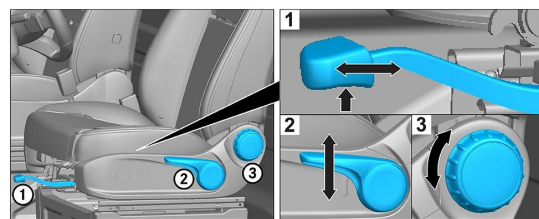

Podešavanje sjedala (mehanički)

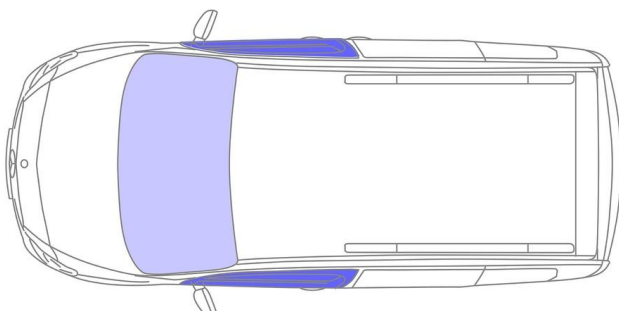

VSG: višeslojno zaštitno staklo

ESG: kaljeno staklo



5. Spremljena energija / tekućine / plinovi / kruta goriva



Svi visokonaponski vodovi imaju narančastu izolaciju.

6. U slučaju požara



Fireman Access in the hold.



Požar vozila ugasite velikom količinom vode (H₂O).
Ohladite litij-ionski akumulator većom količinom vode (H₂O).



Upozorenje: akumulator se može ponovo zapaliti



Ako iz visokonaponskog akumulatora istječe rashladno sredstvo, akumulator može postati nestabilan uslijed toplinskog preopterećenja. Provjerite temperaturu akumulatora infracrvenom toplinskom kamerom.



7. U slučaju uranjanja

Ne postoji opći znak upozorenja da je karoserija pod naponom.

Nakon spašavanja vozila:

1. Pustite da voda izađe iz unutrašnjosti vozila.
2. Deaktivirajte visokonaponski sustav (vidi 3. poglavlje).

8. Transport / skladištenje / odvuci

Transportirajte vozilo samo s objema osovina na vozilu za vuču ili transporterom za automobile.

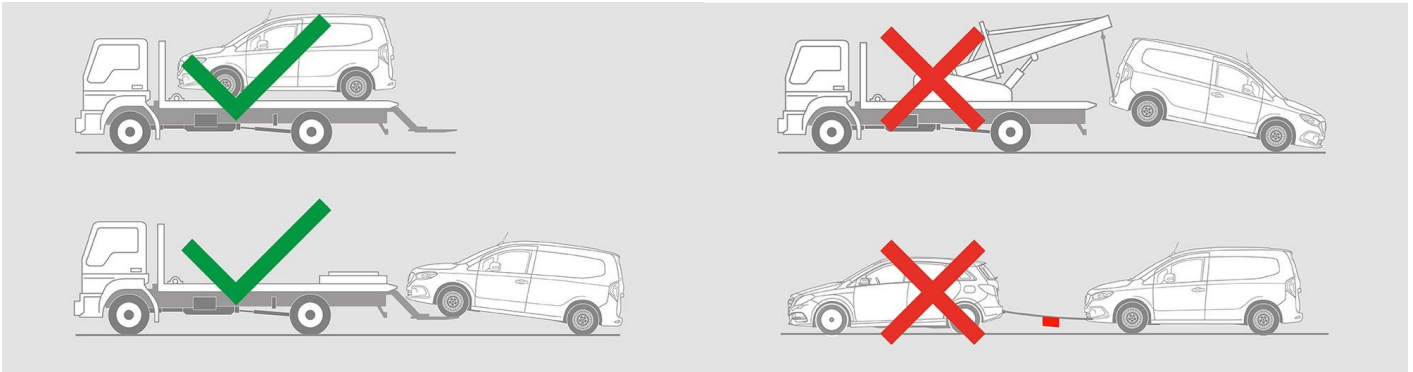

Pohranite ga na sigurnoj udaljenosti od drugih vozila.



Upozorenje: Moguće paljenje baterije



9. Vazne dodatne informacije

Dodatne informacije potražite u [Vodiču za službu za vuču osobnih motornih vozila](#).



10. Objasnjenje piktograma



Električno vozilo



Opći znak upozorenja



Upozorenje, električna



Zapaljivo



Opasno za ljudsko zdravlje



Korozivna tvar



Akutna toksičnost



Uporaba vode prilikom gašenja požara



Safety gloves



Face shield



Uporaba toplinske infracrvene kamere



Poklopac motora



Uklanjanje pametnog ključa



Posebni pristup akumulatoru