

-  Zračni jastuk
-  Plinski generator
-  Zatezač sigurnosnog pojasa
-  SRS upravljački uređaj
-  Plinsko-hidraulični podupirač / zategnuta opruga
-  Niskonaponski akumulator
-  Visokonaponski akumulatorski paket
-  Visokonaponski električni kabel
-  Visokonaponska komponenta
-  Prekid kabela
-  Niskonaponski uređaj koji isključuje visoki napon

Napomena: Dodatne informacije potražite u našem [Vodiču za spašavanje](#).

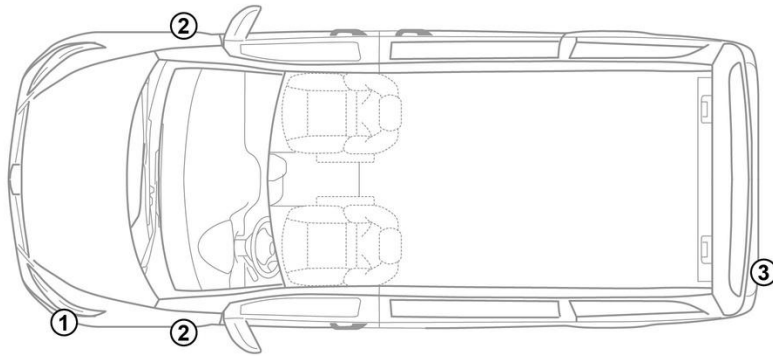

1. Identifikacija



2. Imobilizacija / stabilizacija / dizanje

Elektronička parkirna kočnica – Ovisno o tipu vozila ugrađena je jedna od sljedećih varijanti:



1. Pritisnite ručicu mjenjača u položaj P.
2. Pritisnite ručicu mjenjača u položaj N.

Mehanička parkirna kočnica – Ovisno o tipu vozila ugrađena je jedna od sljedećih varijanti:

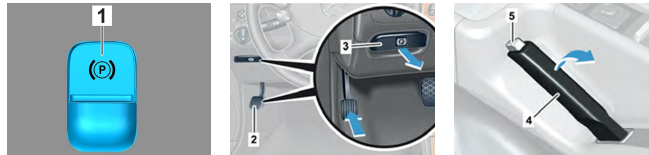

1. Električna parkirna kočnica
2. Papučica parkirne kočnice
3. Otpustite tipku mehaničke parkirne kočnice
4. Poluga parkirne kočnice
5. Otpustite tipku poluge parkirne kočnice

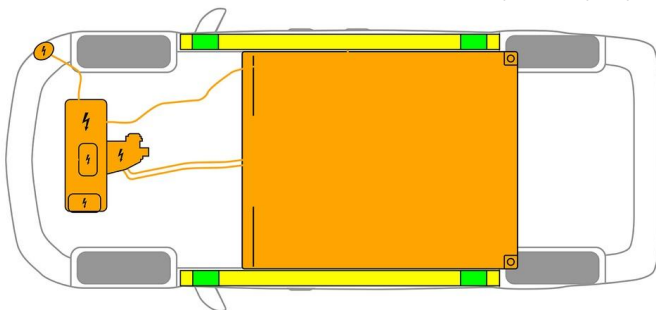

- Prikladne podizne točke
- Prikladne stabilizacijske točke na bočnoj strani
- Visokonaponski akumulator



Morate izbjeći dodatno izobličenje pragova i podvozja tijekom spašavanja (npr. podupiranjem hidrauličkom opremom).

3. Sigurnosni propisi / izključivanje opasnosti

Isključivanje paljenja:

1. Okrenite kontaktni ključ u kontaktnoj bravi u smjeru suprotnom od kazaljke na satu i izvucite ga iz kontaktne brave.
2. Uklonite kontaktni ključ iz vozila.

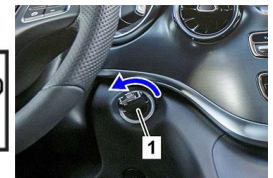

Samo zato što ne čujete zvukove motora, ne znači da je vozilo isključeno.



Vozilo je moguće ponovo pokrenuti dok ga ne stavite izvan pogona.

Deaktivacija visokonaponskog sustava



Visokonaponski sustav automatski se isključuje u slučaju nesreća kad se aktiviraju zračni jastuci ili zatezači sigurnosnih pojaseva.





U svim drugim slučajevima deaktivirajte visokonaponski sustav kako slijedi:



Mogućnost 1: Naprava za isključivanje visokog napona

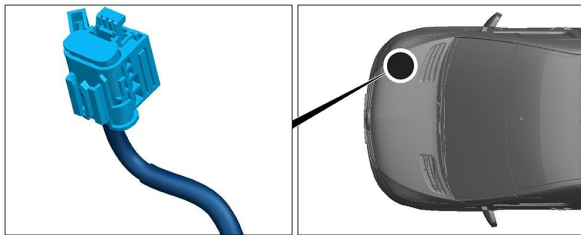

Naprava za isključivanje visokog napona nalazi se u prostoru motora na suvozačevoj strani.



- (1) Povucite deblokadu
- (2) Pritisnite deblokadu prema dolje
- (3) Izvucite sklopku



Mogućnost 2: Alternativna naprava za isključivanje visokog napona

Alternativna naprava za isključivanje visokog napona nalazi se u kutiji prednjeg desnog sjedala. Označena je natpisom.



Uklonite pokrov (1). Prerežite vod na označenom mjestu (2).



Da biste osigurali da u visokonaponskoj mreži više nema preostalog napona, pričekajte cca 20 sekundi nakon isključivanja.



Unutarnja naponska mreža od 12 V i dalje naponom napaja pasivne sigurnosne sustave kao što su zračni jastuci i zatezači sigurnosnih pojaseva.



Odvajanje akumulatora od 12 V

1. Uklonite pokrov akumulatora od 12 V
2. Otpustite minus kabel akumulatora od 12 V na vijčanom spoju i osigurajte ga od neželjenog kontakta.



Deaktiviraju se pasivni sigurnosni sustavi (zračni jastuci i zatezači sigurnosnih pojaseva).



4. Pristup putnicima

Tijekom oslobađanja putnika potrebno je obratiti pozornost na komponente zaštitnog sustava (posebice pirotehničke elemente) u skladu s informacijama na stranici 1.





Podešavanje upravljača



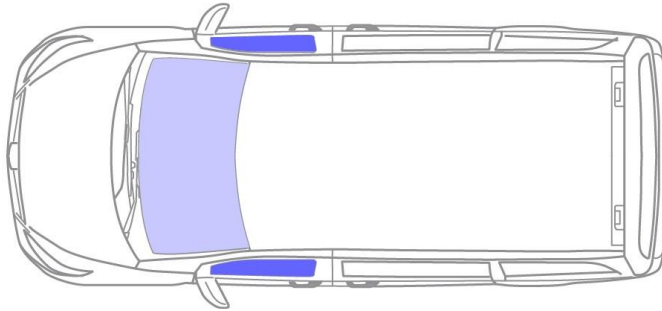















Podešavanje sjedala (mehanički)



 VSG: višeslojno zaštitno staklo

 ESG: kaljeno staklo

5. Spremljena energija / tekućine / plinovi / kruta goriva

	  	12 V
	      	400 V
	  	660 ± 10 g



Svi visokonaponski vodovi imaju narančastu izolaciju.

6. U slučaju požara



Požar vozila ugasiite velikom količinom vode (H₂O).
Ohladite litij-ionski akumulator većom količinom vode (H₂O).



Upozorenje: akumulator se može ponovo zapaliti



Ako iz visokonaponskog akumulatora istječe rashladno sredstvo, akumulator može postati nestabilan uslijed toplinskog preopterećenja. Provjerite temperaturu akumulatora infracrvenom toplinskom kamerom.



7. U slučaju uranjanja

Ne postoji opći znak upozorenja da je karoserija pod naponom.

Nakon spašavanja vozila:

1. Pustite da voda izađe iz unutrašnjosti vozila.
2. Deaktivirajte visokonaponski sustav (vidi 3. poglavlje).



8. Transport / skladištenje / odvuci

Transportirajte vozilo samo s objema osovinama na vozilu za vuču ili transporterom za automobile.

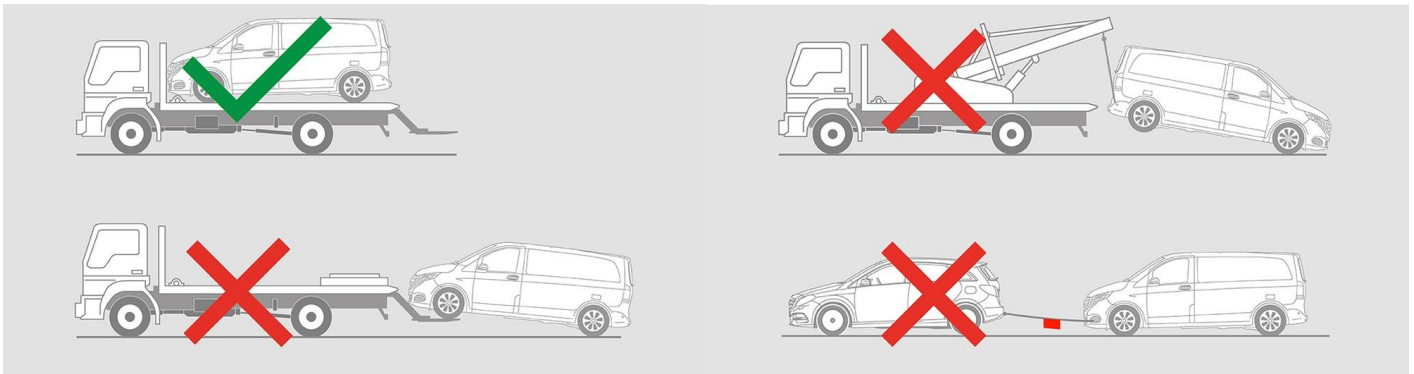



Pohranite ga na sigurnoj udaljenosti od drugih vozila.

 **Upozorenje: Moguće paljenje baterije** 

9. Vazne dodatne informacije

Dodatne informacije potražite u [Vodiču za službu za vuču osobnih motornih vozila](#).

10. Objasnjenje piktograma

	Električno vozilo		Opći znak upozorenja		Upozorenje, elektrika		Zapaljivo
	Opasno za ljudsko zdravlje		Korozivna tvar		Akutna toksičnost		Eksploziv
	Uporaba vode prilikom gašenja požara		Uporaba toplinske infracrvene kamere		Poklopac motora		Uklanjanje pametnog ključa
	Komponenta klima-uređaja		Upozorenje, niska temperatura				