







① Left-hand drive

② Right-hand drive

- | | | | | |
|---|---|--|--|--|
|  Zračni jastuk |  Plinski generator |  Zatezač sigurnosnog pojasa |  Plinsko-hidraulični podupirač / zategnuta opruga |  Područje visoke otpornosti |
|  Niskonaponski akumulator |  Benzin spremnik za gorivo | | | |

Napomena: Dodatne informacije potražite u našem [Vodiču za spašavanje](#).



1. Identifikacija

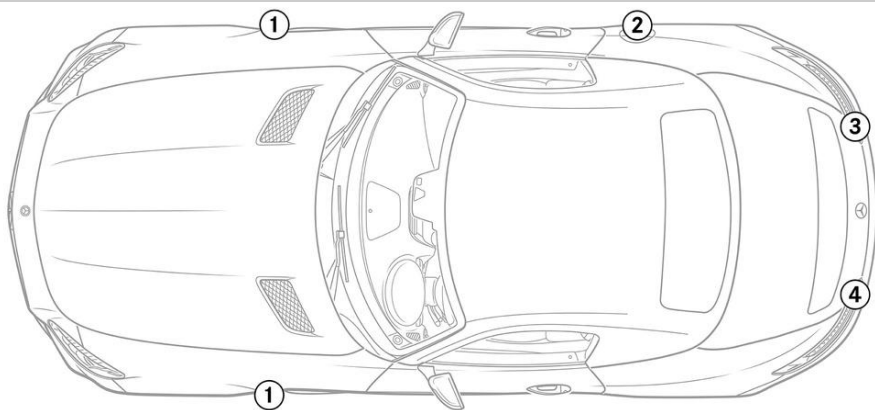

1

V8 BITURBO

2

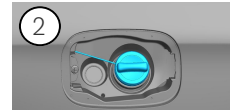

3

GT

4

