









- ① High-voltage charge socket ② Left-hand drive ③ Right-hand drive

- | | | | | |
|---|--|--|--|--|
|  Zračni jastuk |  Plinski generator |  Zatezač sigurnosnog pojasa |  SRS upravljački uređaj |  Plinsko-hidraulični podupirač / zategnuta opruga |
|  Niskonaponski akumulator |  Visokonaponski akumulatorski paket |  Visokonaponska komponenta |  Visokonaponski uređaj koji isključuje visoki napon | |

Napomena: Dodatne informacije potražite u našem [Vodiču za spašavanje](#).



1. Identifikacija

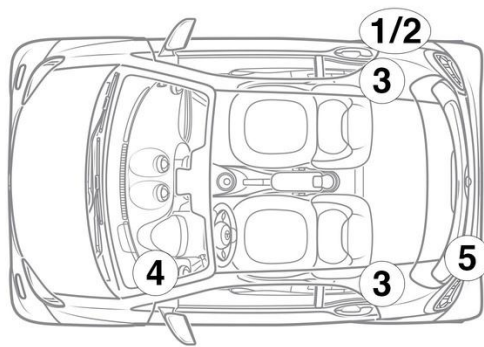

3. Sigurnosni propisi / izključivanje opasnosti

Deaktivacija visokonaponskog sustava

U svim drugim slučajevima deaktivirajte visokonaponski sustav kako slijedi:

Naprava za isključivanje visokog napona

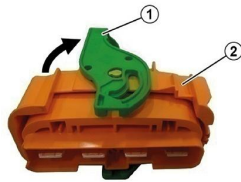
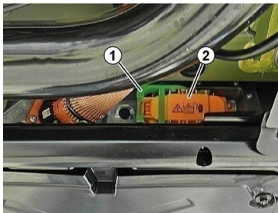

The high-voltage disconnect device is located on the underside of the high-voltage battery on the right at the rear.

Open lock (1) on connector (2) / Unplug connector (2) from high-voltage battery



Da biste osigurali da u visokonaponskoj mreži više nema preostalog napona, pričekajte cca 20 sekundi nakon isključivanja.



Unutarnja naponska mreža od 12 V i dalje naponom napaja pasivne sigurnosne sustave kao što su zračni jastuci i zatezači sigurnosnih pojaseva.



Odvajanje akumulatora od 12 V

1. Uklonite pokrov akumulatora od 12 V
2. Otpustite minus kabel akumulatora od 12 V na vijčanom spoju i osigurajte ga od neželjenog kontakta.