

-  Zračni jastuk
-  Plinski generator
-  Zatezač sigurnosnog pojasa
-  SRS upravljački uređaj
-  Plinsko-hidraulični podupirač / zategnuta opruga
-  Niskonaponski akumulator
-  Visokonaponski akumulatorski paket
-  Visokonaponski električni kabel
-  Visokonaponska komponenta
-  Prekid kabela
-  Niskonaponski uređaj koji isključuje visoki napon



1. Identifikacija



2. Imobilizacija / stabilizacija / dizanje

Elektronička parkirna kočnica

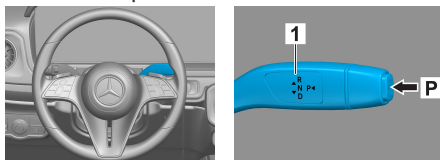

Pritisnite sklopku P na ručici mjenjača (1).
Automatski se aktivira elektronička parkirna kočnica.

Mehanička parkirna kočnica



Električna parkirna kočnica (1)

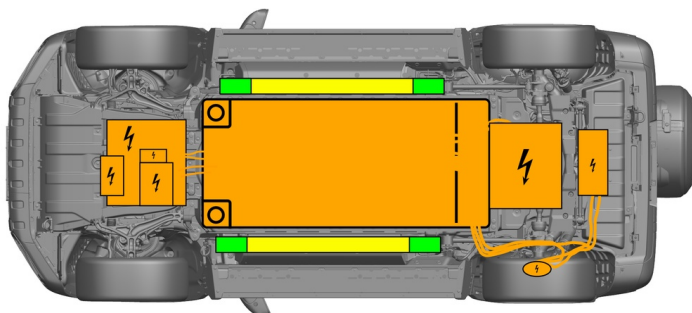

- Prikladne podizne točke
- Prikladne stabilizacijske točke na bočnoj strani
- Visokonaponski akumulator



Morate izbjeći dodatno izobličjenje pragova i podvozja tijekom spašavanja (npr. podupiranjem hidrauličkom opremom).

3. Sigurnosni propisi / isključivanje opasnosti

Isključivanje paljenja:

1. Pritisnite tipku za pokretanje/zaustavljanje bez aktivacije pogonske kočnice.
2. Pohanite elektronički ključ vozila na udaljenosti od najmanje 5 m.

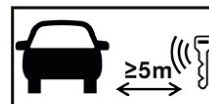

Samo zato što ne čujete zvukove motora, ne znači da je vozilo isključeno.



Vozilo je moguće ponovo pokrenuti dok ga ne stavite izvan pogona.

Deaktivacija visokonaponskog sustava



Visokonaponski sustav automatski se isključuje u slučaju nesreća kad se aktiviraju zračni jastuci ili zatezači sigurnosnih pojaseva.



A 000 817 90 06

U svim drugim slučajevima deaktivirajte visokonaponski sustav kako slijedi:

Mogućnost 1: Naprava za isključivanje visokog napona

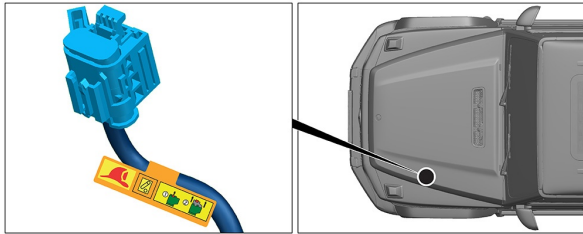

Vysokovoltové vypínacie zariadenie sa nachádza v motorovom priestore na strane vodiča.



- (1) Povucite otključavanje
- (2) Pritisnite otključavanje prema dolje
- (3) Vytiahnite vypínač.



Mogućnost 2: Alternativna naprava za isključivanje visokog napona

Zamjenski uređaj za isključivanje visokog napona nalazi se dolje u A-stupu na suvozačevoj strani. Označen je natpisom s uputom.

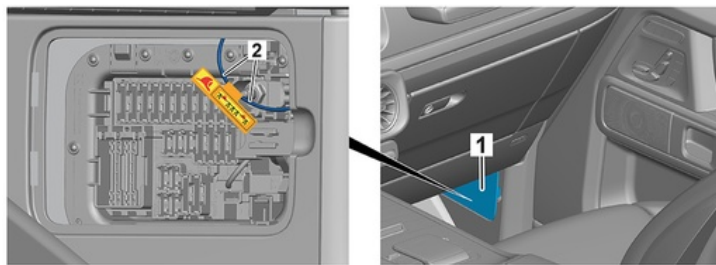

Uklonite pokrov (1). Prerežite vod na označenom mjestu (2).



Da biste osigurali da u visokonaponskoj mreži više nema preostalog napona, pričekajte cca 20 sekundi nakon isključivanja.



Unutarnja naponska mreža od 12 V i dalje naponom napaja pasivne sigurnosne sustave kao što su zračni jastuci i zatezači sigurnosnih pojaseva.



Odvajanje akumulatora od 12 V

1. Uklonite pokrov akumulatora od 12 V u prtljažniku. Servisni se poklopac za to nalazi u lijevoj bočnoj oklopnoj ploči.
2. Otpustite minus-kabel akumulatora od 12 V na vijčanom spoju i osigurajte ga od neželjenog kontakta.

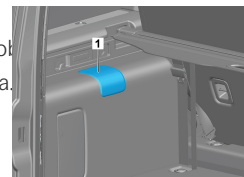

Deaktiviraju se pasivni sigurnosni sustavi (zračni jastuci i zatezači sigurnosnih pojaseva).



4. Pristup putnicima

Tijekom oslobađanja putnika potrebno je obratiti pozornost na komponente zaštitnog sustava (posebice pirotehničke elemente) u skladu s informacijama na stranici 1.

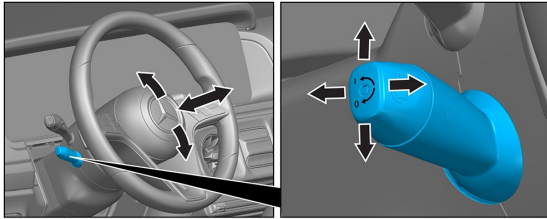

Podešavanje upravljača

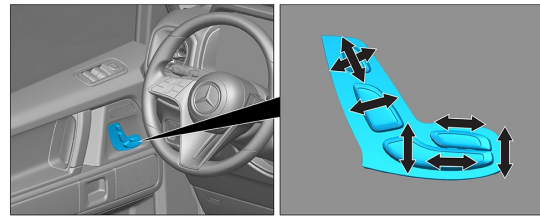



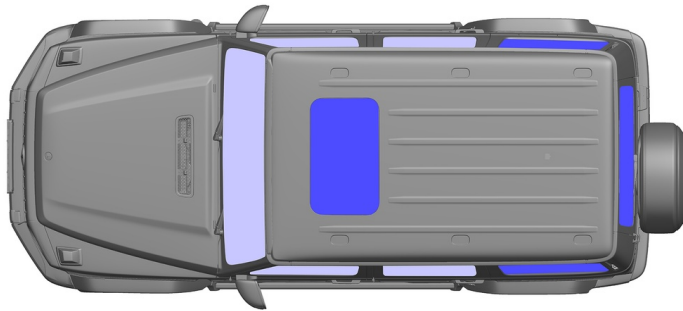











Podešavanje sjedala (električki)



 VSG: višeslojno zaštitno staklo

 ESG: kaljeno staklo

5. Spremljena energija / tekućine / plinovi / kruta goriva

	  	12 V AGM
	     	400 V
	  	750 ± 10 g



Svi visokonaponski vodovi imaju narančastu izolaciju.

6. U slučaju požara



Požar vozila ugasite velikom količinom vode (H₂O).
Ohladite litij-ionski akumulator većom količinom vode (H₂O).



Upozorenje: Moguće paljenje baterije



Ako iz visokonaponskog akumulatora istječe rashladno sredstvo, akumulator može postati nestabilan uslijed toplinskog preopterećenja. Provjerite temperaturu akumulatora infracrvenom toplinskom kamerom.



7. U slučaju uranjanja

Ne postoji opći znak upozorenja da je karoserija pod naponom.

Nakon spašavanja vozila:

1. Pustite da voda izađe iz unutrašnjosti vozila.
2. Deaktivirajte visokonaponski sustav (vidi 3. poglavlje).



8. Transport / skladištenje / odvući

Transportirajte vozilo samo s objema osovinama na vozilu za vuču ili transporterom za automobile.

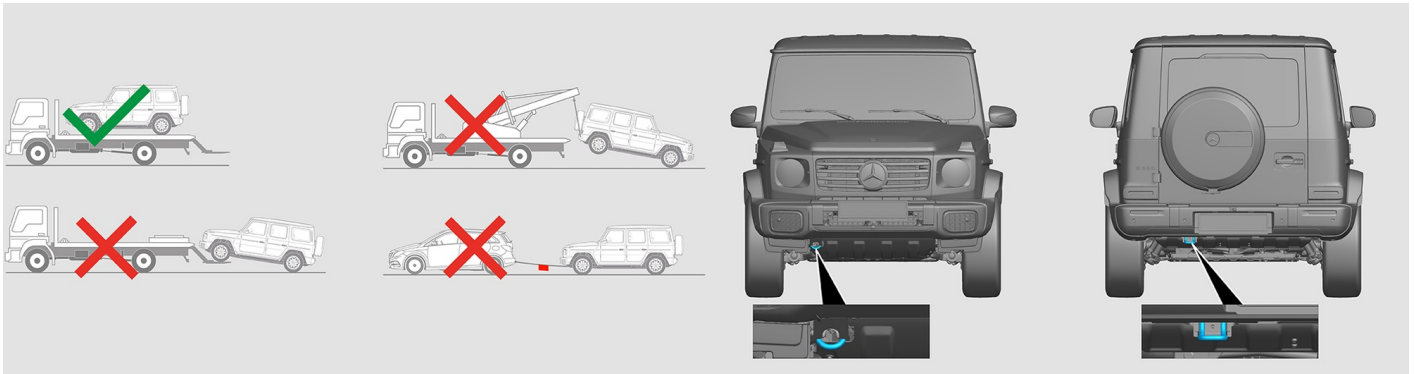

Pohranite ga na sigurnoj udaljenosti od drugih vozila.



Upozorenje: Moguće paljenje baterije



9. Vazne dodatne informacije

Dodatne informacije potražite u [Vodiču za službu za vuču osobnih motornih vozila](#).

Napomena: Dodatne informacije potražite u našem [Vodiču za spašavanje](#).

10. Objasnjenje piktograma



Električno vozilo



Opći znak upozorenja



Upozorenje, električna



Zapaljivo



Opasno za ljudsko zdravlje



Korozivna tvar



Akutna toksičnost



Eksplziv



Uporaba vode prilikom gašenja požara



Uporaba toplinske infracrvene kamere



Poklopac motora



Prtljažnik



Uklanjanje pametnog ključa



Komponenta klima-uređaja



Upozorenje, niska temperatura