









- |   |  |   |  |  |
|---|--|---|--|--|
|  Zračni jastuk           |  Zatezač sigurnosnog pojasa         |  SRS upravljački uređaj    |  Plinsko-hidraulični podupirač / zategnuta opruga   |  Područje visoke otpornosti |
|  Niskonaponski akumulator |  Visokonaponski akumulatorski paket |  Visokonaponska komponenta |  Visokonaponski uređaj koji isključuje visoki napon |  |

Napomena: Dodatne informacije potražite u našem [Vodiču za spašavanje](#).



## 1. Identifikacija

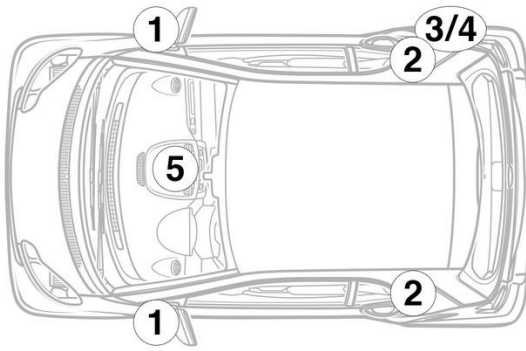

## 3. Sigurnosni propisi / izključivanje opasnosti

### Deaktivacija visokonaponskog sustava

U svim drugim slučajevima deaktivirajte visokonaponski sustav kako slijedi:

#### Naprava za isključivanje visokog napona



The high-voltage disconnect device is located on the underside of the high-voltage battery on the left at the rear.

Remove cover (1) / Open lock (2) on connector (3) / Unplug connector (3) from high-voltage battery



Da biste osigurali da u visokonaponskoj mreži više nema preostalog napona, pričekajte cca 20 sekundi nakon isključivanja.



Unutarnja naponska mreža od 12 V i dalje naponom napaja pasivne sigurnosne sustave kao što su zračni jastuci i zatezači sigurnosnih pojaseva.



#### Odvajanje akumulatora od 12 V

1. Uklonite pokrov akumulatora od 12 V
2. Otpustite minus kabel akumulatora od 12 V na vijčanom spoju i osigurajte ga od neželjenog kontakta.