

-  Airbag
-  Générateur de gaz
-  Prétensionneur de ceinture de sécurité
-  Unité de contrôle SRS
-  Vérin à gaz/resort précontraint
-  Batterie basse tension
-  Essence réservoir à carburant

Remarque: Pour obtenir de plus amples informations, veuillez consulter notre [guide de réponse d'urgence](#).



1. Identification / reconnaissance



2  
**GLE 350**

2. Immobilisation / stabilisation / levage

Frein de parking

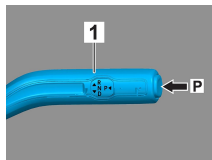

Frein de stationnement

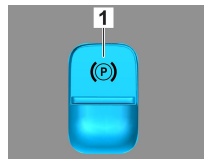
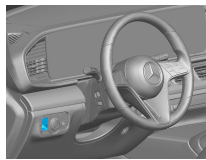

Appuyer sur le bouton P sur le levier de vitesses (1). Le frein de parking est automatiquement activé.

Frein de stationnement électrique (1)

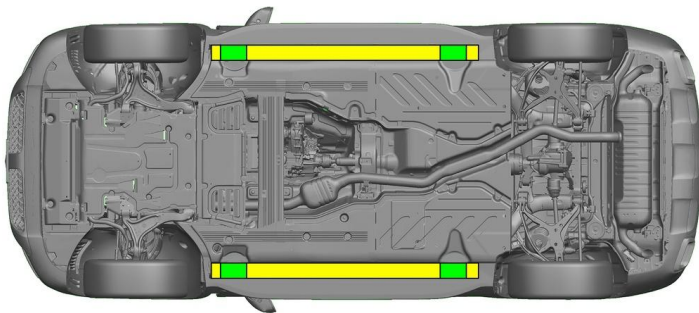

Points de levage adaptés



Points de stabilisation adaptés sur le côté



Une déformation supplémentaire des longerons et du dessous de caisse pendant la désincarcération (p. ex. dans le cadre d'un étayage avec équipement hydraulique) doit être évitée.

3. Neutraliser les dangers directs / règles de sécurité

Couper le contact :

1. Appuyer sur le bouton START-STOP sans actionner le frein de service.
2. Conserver la clé de véhicule électronique à une distance d'au moins 5 m.

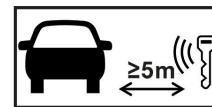

L'absence de bruits de moteur ne signifie pas forcément que le véhicule est à l'arrêt complet.



Un redémarrage est possible tant que le véhicule n'est pas mis hors service.



Couper la batterie 12 V / 48 V

1. Retirer le cache de la batterie 12/48 V.
2. Desserrer le câble moins de la batterie 12/48 V au niveau du raccord vissé et le protéger contre tout contact involontaire.



Les systèmes de sécurité passifs (airbags et prétensionneurs de ceinture de sécurité) sont désactivés.



### 4. Accès aux occupants

Lors de la sortie des occupants du véhicule, tenir compte des éléments des systèmes de retenue (en particulier les éléments pyrotechniques) conformément aux données de la page 1.

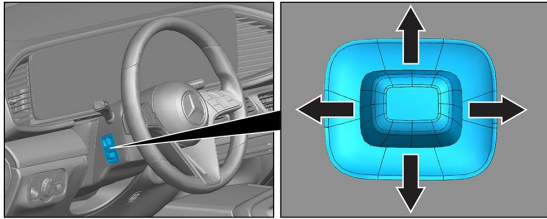

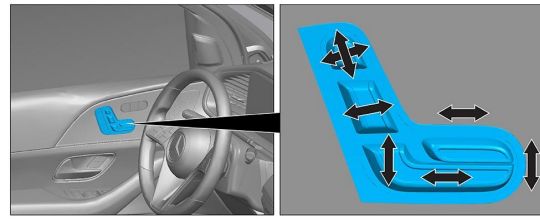

Réglage du volant



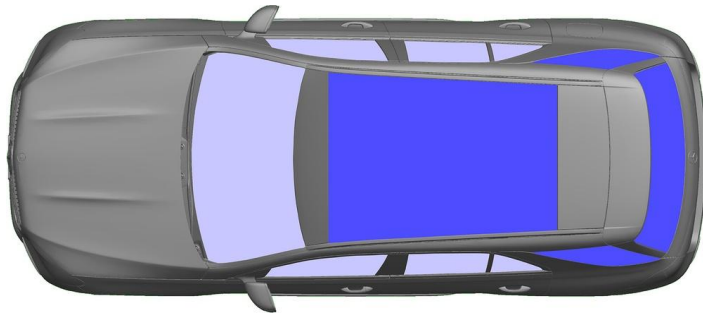











Réglage du siège (électrique)



 VSG : verre de sécurité feuilleté  
 ESG : verre de sécurité trempé

### 5. Énergie stockée / liquides / gaz / solides

	    	12/48V
	 	85L
	  	660 ± 10g

### 6. En cas d'incendie



Pour éteindre un feu de véhicule, utiliser de grandes quantités d'eau (H<sub>2</sub>O).

### 7. En cas d'immersion

Il n'existe aucun risque que la carrosserie soit sous tension. Après le dégagement / l'évacuation du véhicule :

1. Laisser l'eau s'écouler de l'habitacle.
2. Procéder à la désactivation du réseau de bord 12 V / 48 V (voir chapitre 3).

### 8. Remorquage / transport / stockage

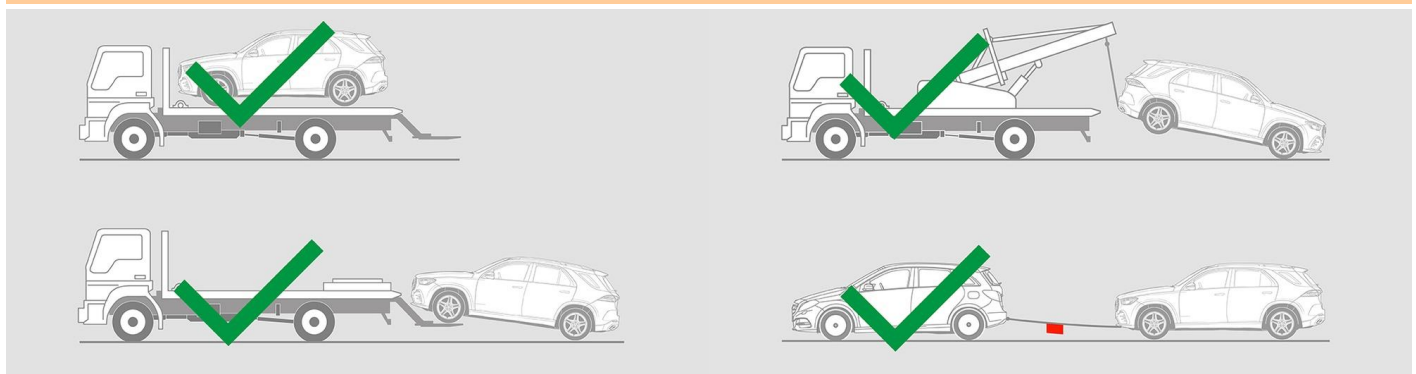



## 9. Informations complémentaires importantes

Pour obtenir de plus amples informations, consulter le [guide pour le remorquage de véhicules particuliers](#).

## 10. Explication des pictogrammes utilisés



Véhicule fonctionnant avec un carburant liquide du groupe 2



Signe générique d'avertissement



Inflammable



Dangereux pour la santé humaine



Corrosif



Toxicité aigüe



Explosif



Utiliser de l'eau pour éteindre l'incendie



Utiliser de la mousse sèche pour éteindre l'incendie



Utiliser de la mousse pour éteindre l'incendie



Eloigner la clé main-libre



Composant de climatisation



Avertissement, basse température