

-  Airbag
-  Générateur de gaz
-  Prétensionneur de ceinture de sécurité
-  Unité de contrôle SRS
-  Vérin à gaz/resort précontraint
-  Batterie basse tension
-  Essence réservoir à carburant
-  Bloc-batterie, haute tension
-  Câble d'alimentation haute tension
-  Composant haute tension
-  Coupure de câble
-  Dispositif de déconnexion basse tension de la batterie haute tension

Remarque: Pour obtenir de plus amples informations, veuillez consulter notre [guide de réponse d'urgence](#).

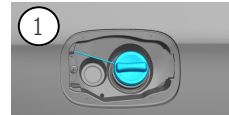

1. Identification / reconnaissance



2
4MATIC



3
GLE 400e

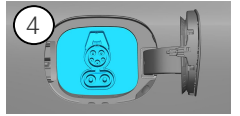

2. Immobilisation / stabilisation / levage

Frein de parking

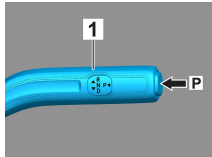

Frein de stationnement

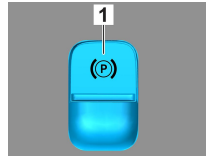
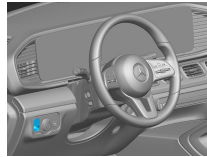

Appuyer sur le bouton P sur le levier de vitesses (1). Le frein de parking est automatiquement activé.

Frein de stationnement électrique (1)

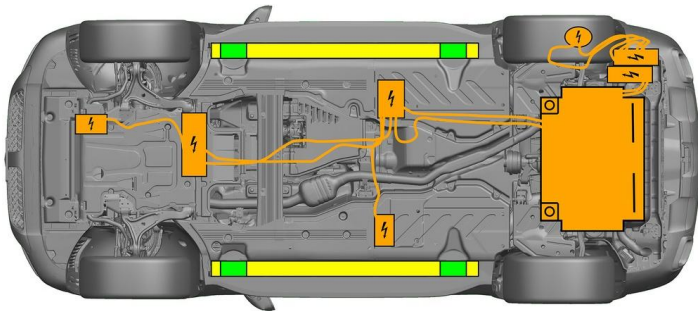

Points de levage adaptés



Points de stabilisation adaptés sur le côté



Une déformation supplémentaire des longerons et du dessous de caisse pendant la désincarcération (p. ex. dans le cadre d'un étayage avec équipement hydraulique) doit être évitée.

3. Neutraliser les dangers directs / règles de sécurité

Couper le contact :

1. Appuyer sur le bouton START-STOP sans actionner le frein de service.
2. Conserver la clé de véhicule électronique à une distance d'au moins 5 m.



L'absence de bruits de moteur ne signifie pas forcément que le véhicule est à l'arrêt complet.



Un redémarrage est possible tant que le véhicule n'est pas mis hors service.

Désactivation du système haute tension



En cas d'accidents avec déclenchement des airbags et prétensionneurs de ceinture de sécurité, le système haute tension est automatiquement mis hors circuit.



A 000 817 90 06



Dans tous les autres cas, le système haute tension doit être désactivé comme suit :

Option 1: Sectionneur haute tension

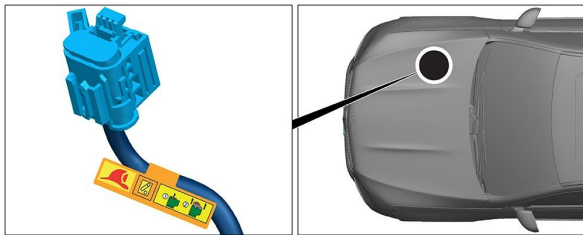

Le sectionneur haute tension se trouve dans le compartiment moteur du côté passager avant.



- (1) Tirer le mécanisme de déverrouillage
- (2) Abaisser le mécanisme de déverrouillage
- (3) Extraire le commutateur



Option 2: Sectionneur haute tension secondaire

Le sectionneur haute tension secondaire se trouve sous le cache de la boîte à fusibles sur le tableau de bord du côté conducteur. Il est pourvu d'une étiquette d'avertissement.

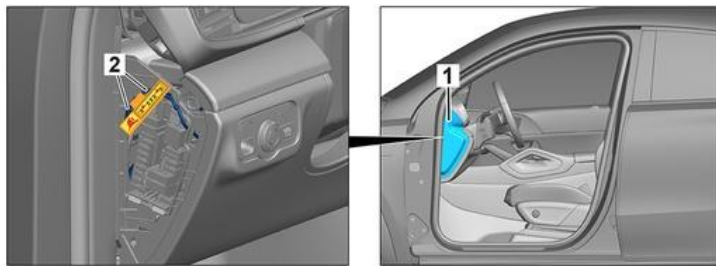

Retirer le cache (1). Sectionner le câble à l'endroit indiqué (2).



Afin de s'assurer de l'absence de tension résiduelle dans le réseau haute tension, patienter env. 20 secondes après la mise hors circuit.



Les systèmes de sécurité passifs tels que les airbags et les prétensionneurs de ceinture de sécurité sont encore alimentés par le réseau de bord 12 V.



Couper la batterie 12 V

1. Retirer le cache de la batterie 12 V.
2. Desserrer le câble moins de la batterie 12 V au niveau du raccord vissé et le protéger contre tout contact involontaire.



Les systèmes de sécurité passifs (airbags et prétensionneurs de ceinture de sécurité) sont désactivés.



4. Accès aux occupants

Lors de la sortie des occupants du véhicule, tenir compte des éléments des systèmes de retenue (en particulier les éléments pyrotechniques) conformément aux données de la page 1.



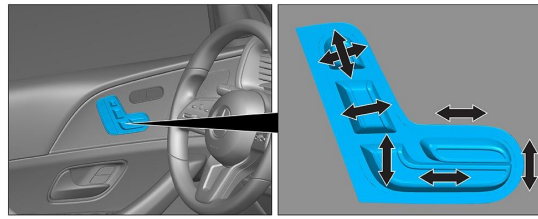

Réglage du volant



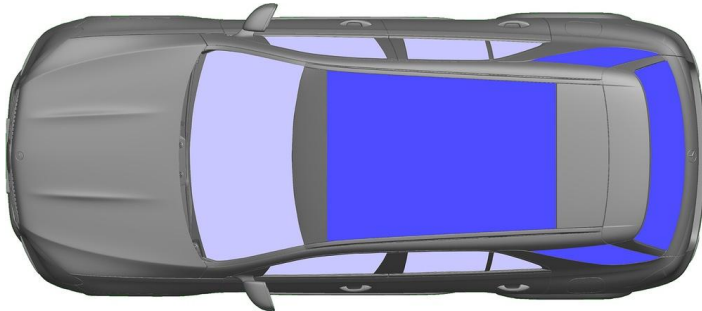

















Réglage du siège (électrique)



 VSG : verre de sécurité feuilleté

 ESG : verre de sécurité trempé

5. Énergie stockée / liquides / gaz / solides

	  	12V
	      	400V
	 	65L
	  	700 ± 10g



Tous les câbles haute tension sont pourvus d'une isolation de couleur orange.

6. En cas d'incendie



Pour éteindre un feu de véhicule, utiliser de grandes quantités d'eau (H₂O).
Pour refroidir la batterie lithium-ion, utiliser de grandes quantités d'eau (H₂O).



Avertissement : réinflammation de la batterie



En cas de fuite de liquide de refroidissement sur la batterie haute tension, la batterie peut devenir instable en raison d'une surcharge thermique. Vérifier la température de la batterie au moyen d'une caméra thermique infrarouge.



7. En cas d'immersion

Il n'existe aucun risque que la carrosserie soit sous tension.

Après le dégagement / l'évacuation du véhicule :

1. Laisser l'eau s'écouler de l'habitacle.
2. Procéder à la désactivation du système haute tension (voir chapitre 3).



8. Remorquage / transport / stockage

Transporter le véhicule uniquement avec les deux essieux sur une dépanneuse ou un porte-voitures.

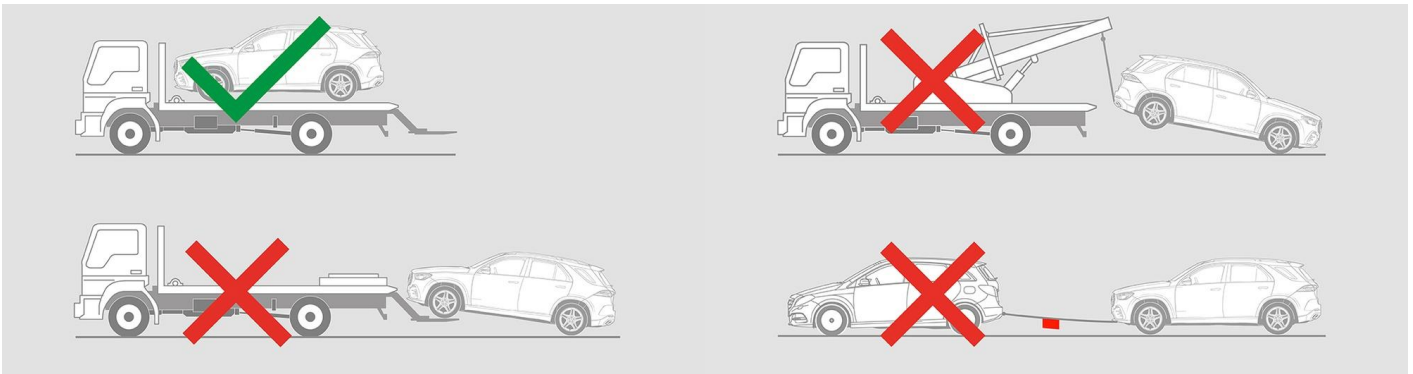













Garder les distances de sécurité avec les autres véhicules.

 Avertissement : réinflammation de la batterie 

9. Informations complémentaires importantes

Pour obtenir de plus amples informations, consulter le [guide pour le remorquage de véhicules particuliers](#).

10. Explication des pictogrammes utilisés

- | | | | |
|---|--|--|--|
|  Véhicule électrique hybride fonctionnant avec un carburant liquide du groupe 2 |  Signe générique d'avertissement |  Avertissement, électricité |  Inflammable |
|  Dangereux pour la santé humaine |  Corrosif |  Toxicité aigüe |  Explosif |
|  Utiliser de l'eau pour éteindre l'incendie |  Utiliser une caméra thermique infrarouge |  Capot |  Eloigner la clé main-libre |
|  Composant de climatisation |  Avertissement, basse température | | |