









- | | | | | |
|--|---|---|---|---|
|  Turvatyyny |  Kaasugeneraattori |  Turvavyön kiristin |  SRS-ohjainlaite |  Aktiivinen jalankulkijasuojajärjestelmä |
|  Kaasujousi / esijännitetty jousi |  Matalajänniteakku |  Diesel polttoainesäiliö | | |

Ohje: Katso lisätietoja [pelastusohjeestamme](#).



1. Ajoneuvon tunnistaminen/ identifiointi



2

CLA 220d

3

4MATIC

2. Ajoneuvon sammuttaminen / stabilointi

Seisontajarru

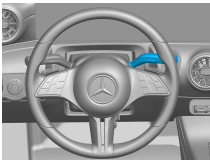

Seisontajarru

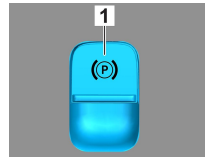

Paina kytkintä P vaihtevalitsimessä (1).
Seisontajarru aktivoidaan automaattisesti.

Sähköinen seisontajarru (1)

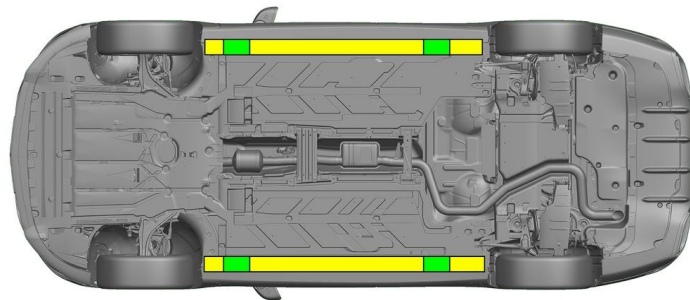

Soveltuvat nostopisteet



Soveltuvat vakautuspisteet sivulla



Kynnyksen ja pohjan lisääntyminen pelastuksen aikana (esim. tuenta hydraulikkavarusteilla) on vältettävä.

3. Ajoneuvon vaarattomaksi tekeminen

Kytke sytytysvirta pois päältä:

1. Paina START-STOP-painiketta painamatta käyttöjarrua.
2. Säilytä ajoneuvon sähköinen avain vähintään 5 metrin etäisyydellä.

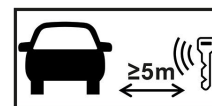

Moottorin äänien puuttuminen ei tarkoita, että ajoneuvo on kytketty pois päältä.



Uudelleenkäynnistys on mahdollista ajoneuvon käytöstäpoistamiseen asti.



12 V:n akun kytkeminen irti

1. Poista 12 V:n akun suojus moottoritilasta.
2. Irrota 12 V:n akun miinusjohto ruuviliitännästä ja varmista tahattoman kosketuksen estämiseksi.



Passiiviset turvajärjestelmät (turvatyyny ja turvavyönkiristimet) deaktivoidaan.



4. Ajoneuvon sisällä olevien pelastaminen

Vapautettaessa autossa matkustavia henkilöitä on huomioitava turvavarusteiden komponentit (erityisesti pyrotekniset elementit) sivulla 1 olevien tietojen mukaisesti.

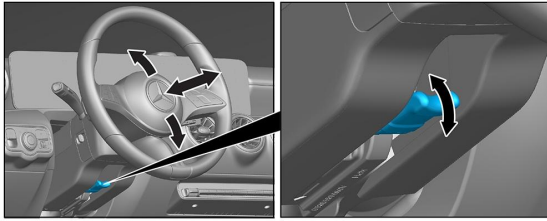

Ohjauspyörän säätö

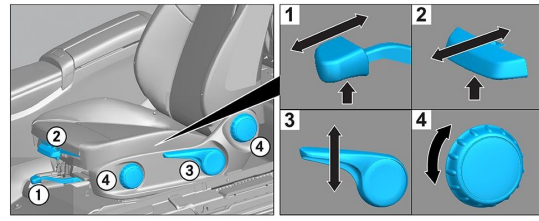

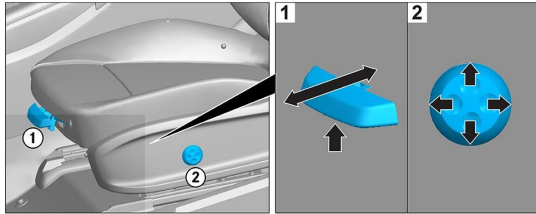

Istuimen säätö (mekaaninen)



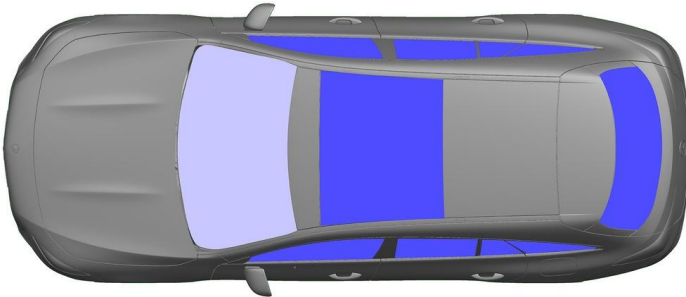

Istuimen säätö (sähköinen)



 VSG: Laminoitu varmuuslasi
 ESG: Karkaistu varmuuslasi

5. Ajoneuvon käyttövoima, nesteet, kiinteät aineet

	  	12V
	 	43L
	  	530 ± 10g

6. Toimenpiteet tulipalon sattuessa



Käytä ajoneuvopalon sammuttamiseen suuria määriä vettä (H₂O).

7. Toimenpiteet auton joutuessa hukuksiin

Ei ole vaaraa, että korissa olisi jännite. Ajoneuvon pelastamisen jälkeen:

1. Anna veden virrata pois sisätilasta.
2. Deaktivoi ajoneuvon 12 V:n / 48 V:n sähköverkko (katso luku 3).



8. Hinaaminen / Kuljetus / Varastointi

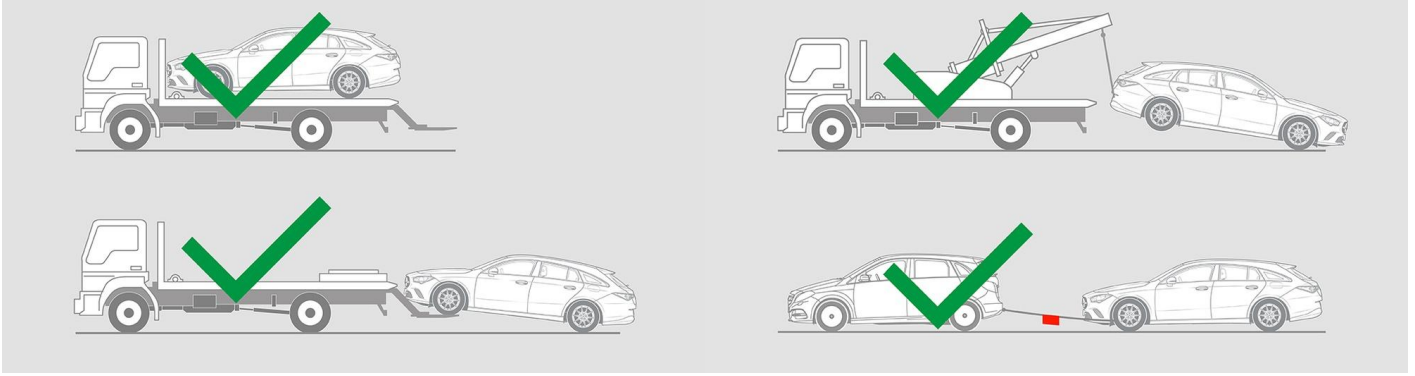

9. Tärkeitä lisätietoja

Lisätietoja on kohdassa [Ohjeet henkilöautojen hinauspalveluille](#).

10. Merkkien selitykset

	Luokan 1 nestemäisiä polttoaineita käyttävä auto		Vaara		Syttyvä		Terveydelle haitallinen
	Syövyttävä		Herkästi räjähtävä		Sammuta vedellä		Sammuta kuivalla vaahdolla
	Sammuta kostealla vaahdolla		Konepelti		Smart-avaimen poistaminen		Air-conditioning component
	Warning; low temperature						