







- |  |   |  |   |  |
|--|---|--|---|--|
|  Turvatyyny       |  Kaasugeneraattori       |  Turvavyön kiristin |  SRS-ohjainlaite |  Kaasujousi / esijännitetty jousi |
|  Matalajänniteakku |  Diesel polttoainesäiliö |  |   |  |

Ohje: Katso lisätietoja [pelastusohjeestamme](#).



## 1. Ajoneuvon tunnistaminen/ identifiointi

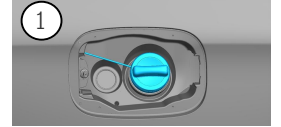

## 2. Ajoneuvon sammuttaminen / stabilointi

### Seisontajarru



### Seisontajarru

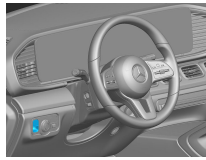

Paina kytkintä P vaihteenvältsimessä (1).

Seisontajarru aktivoidaan automaattisesti.

Sähköinen seisontajarru (1)

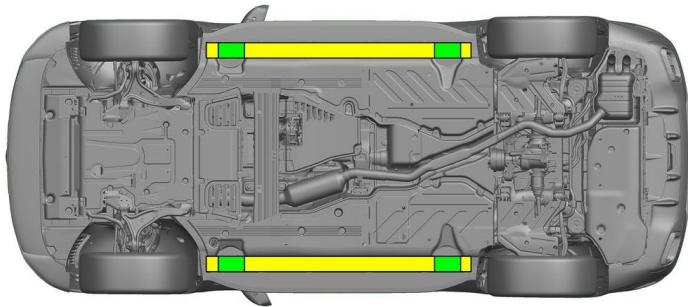

Soveltuvat nostopisteet



Soveltuvat vakautuspisteet sivulla



Kynnyksen ja pohjan lisääntyminen pelastuksen aikana (esim. tuenta hydraulikkavarusteilla) on vältettävä.

## 3. Ajoneuvon vaarattomaksi tekeminen

Kytke sytytysvirta pois päältä:

1. Paina START-STOP-painiketta painamatta käyttöjarrua.

2. Säilytä ajoneuvon sähköinen avain vähintään 5 metrin etäisyydellä.

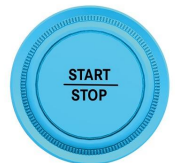
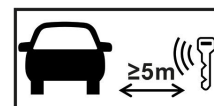

Moottorin äänien puuttuminen ei tarkoita, että ajoneuvo on kytketty pois päältä.



Uudelleenkäynnistys on mahdollista ajoneuvon käytöstäpoistamiseen asti.



### 12 V:n akun kytkeminen irti

1. Poista 12 V:n akun suojus.

2. Irrota 12 V:n akun miinusjohto ruuviliitännästä ja varmista tahattoman kosketuksen estämiseksi.



Passiiviset turvajärjestelmät (turvatyynyt ja turvavyönkiristimet) deaktivoidaan.



#### 4. Ajoneuvon sisällä olevien pelastaminen

Vapautettaessa autossa matkustavia henkilöitä on huomioitava turvavarusteiden komponentit (erityisesti pyrotekniset elementit) sivulla 1 olevien tietojen mukaisesti.

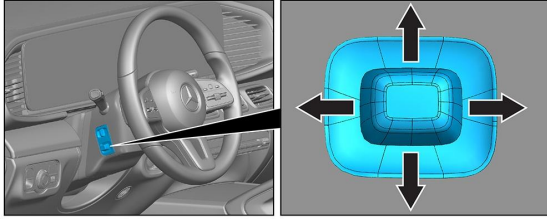

Ohjauspyörän säätö

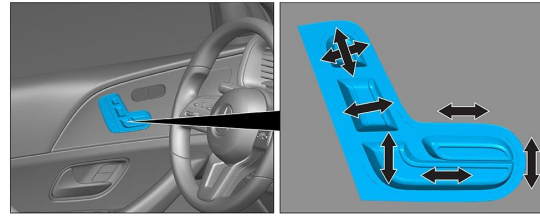



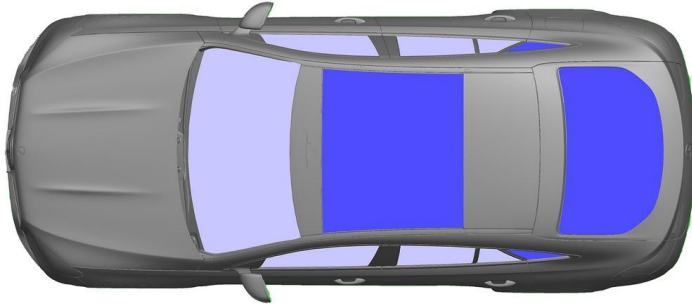

Istuimen säätö (sähköinen)

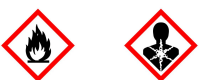

- VSG: Laminoitu varmuuslasi
- ESG: Karkaistu varmuuslasi

#### 5. Ajoneuvon käyttövoima, nesteet, kiinteät aineet

		12V
		85L
		660 ± 10g

#### 6. Toimenpiteet tulipalon sattuessa



Käytä ajoneuvopalon sammuttamiseen suuria määriä vettä (H<sub>2</sub>O).

#### 7. Toimenpiteet auton joutuessa hukuksiin

Ei ole vaaraa, että korissa olisi jännite. Ajoneuvon pelastamisen jälkeen:

1. Anna veden virrata pois sisätilasta.
2. Deaktivoi ajoneuvon 12 V:n / 48 V:n sähköverkko (katso luku 3).

#### 8. Hinaaminen / Kuljetus / Varastointi

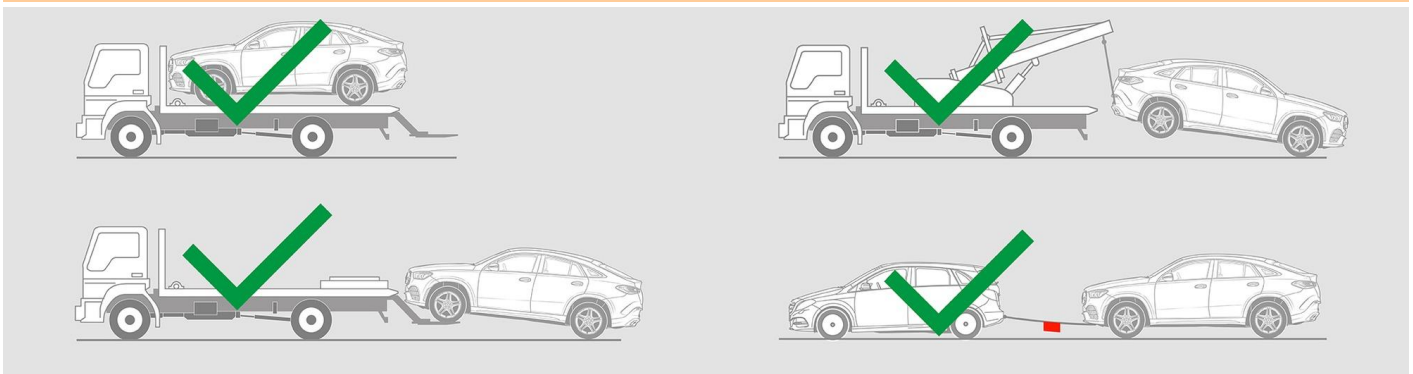



## 9. Tärkeitä lisätietoja

Lisätietoja on kohdassa [Ohjeet henkilöautojen hinauspalveluille](#).

## 10. Merkkien selitykset



Luokan 1 nestemäisiä polttoaineita käyttävä auto



Vaara



Syttyvä



Terveydelle haitallinen



Syövyttävä



Herkästi räjähtävä



Sammuta vedellä



Sammuta kuivalla vaahdolla



Sammuta kostealla vaahdolla



Smart-avaimen poistaminen



Air-conditioning component



Warning; low temperature