

-  Turvatyyny
-  Kaasugeneraattori
-  Turvavyön kiristin
-  SRS-ohjainlaite
-  Aktiivinen jalankulkijasuojajärjestelmä
-  Kaasujousi / esijännitetty jousi
-  Matalajänniteakku
-  Diesel polttoainesäiliö
-  Korkeajänniteakku
-  Korkeajännitejohdot
-  Korkeajännite Komponentit
-  Vaihtoehtoinen korkeajännitteen poiskytkentälaitte
-  Korkeajännitteen katkaisukohta (pienjännite-elementti)

Ohje: Katso lisätietoja [pelastusohjeestamme](#).

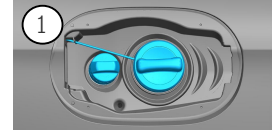

1. Ajoneuvon tunnistaminen/ identifiointi



2. Ajoneuvon sammuttaminen / stabilointi

Seisontajarru

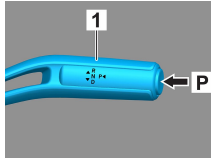
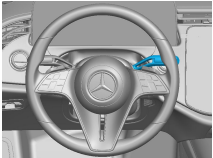

Seisontajarru

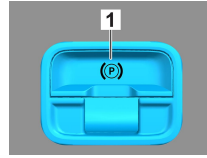



Paina kytkintä P vaihteenvaihtimessa (1).

Seisontajarru aktivoidaan automaattisesti.

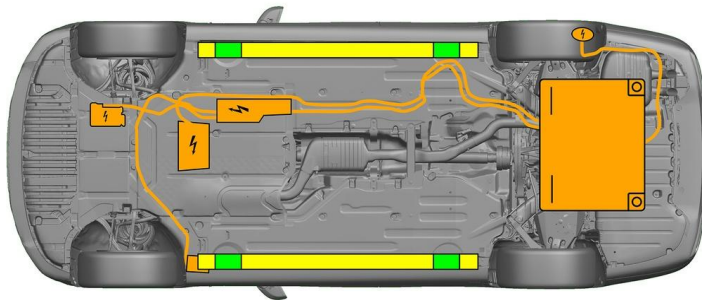
Sähköinen seisontajarru (1)



-  Soveltuvat nostopisteet
-  Soveltuvat vakautuspisteet sivulla
-  Korkeajänniteakku



Kynnyksen ja pohjan lisääntyminen pelastuksen aikana (esim. tuenta hydraulikkavarusteilla) on vältettävä.

3. Ajoneuvon vaarattomaksi tekeminen

Kytke sytytysvirta pois päältä:

1. Paina START-STOP-painiketta painamatta käyttöjarrua.
2. Säilytä ajoneuvon sähköinen avain vähintään 5 metrin etäisyydellä.



Moottorin äänien puuttuminen ei tarkoita, että ajoneuvo on kytketty pois päältä.



Uudelleenkäynnistys on mahdollista ajoneuvon käytöstäpoistamiseen asti.

Korkeajännitejärjestelmän deaktivointi



Korkeajännitejärjestelmä kytketään automaattisesti pois päältä sellaisten onnettomuuksien tapauksessa, joissa turvatyyny ja turvavyönkiristimet laukeavat.





Kaikissa muissa tapauksissa korkeajännitejärjestelmä on deaktivoitava seuraavasti:

Vaihtoehto 1: Korkeajännitteen poiskytkentälaite

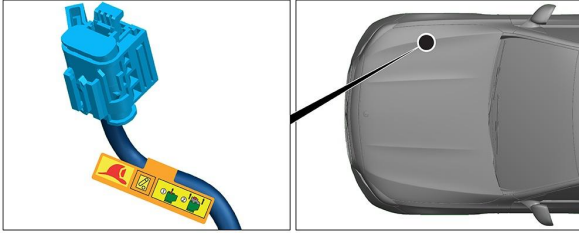

Korkeajännitteen poiskytkentälaite sijaitsee moottoritilassa etumatkustajan puolella.

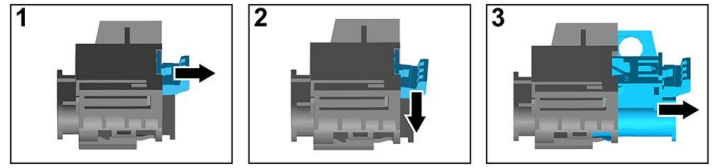

- (1) Vedä lukituksenavauksesta
- (2) Paina lukituksenavaus alas
- (3) Vedä kytkin ulos



Vaihtoehto 2: Vaihtoehtoinen korkeajännitteen poiskytkentälaite

Vaihtoehtoinen korkeajännitteen poiskytkentälaite sijaitsee sulakekotelon suojuksen alla kojelaudassa kuljettajan puolella. Se on merkitty ohjekilvellä.

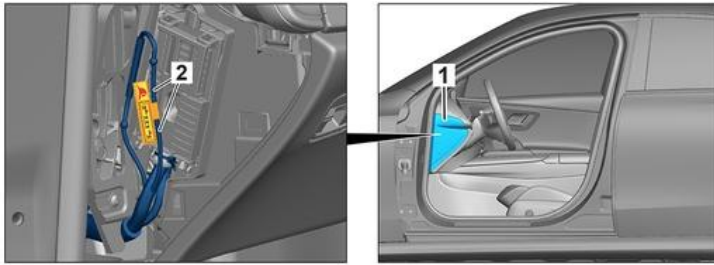

Poista suojus (1). Katkaise johto merkitystä kohdasta (2).



Odota poiskytkennän jälkeen n. 20 sekuntia sen varmistamiseksi, ettei korkeajänniteverkossa ole enää jäännösjännitystä.



Ajoneuvon 12 V:n sähköverkko syöttää edelleen virtaa passiivisille turvajärjestelmille, kuten turvatyynyille ja turvavyönkiristimille.



12 V:n akun kytkeminen irti

1. Poista 12 V:n akun suojus moottoritilasta.
2. Irrota 12 V:n akun miinusjohto ruuviliitännästä ja varmista tahattoman kosketuksen estämiseksi.



Passiiviset turvajärjestelmät (turvatyyny ja turvavyönkiristimet) deaktivoidaan.



4. Ajoneuvon sisällä olevien pelastaminen

Vapautettaessa autossa matkustavia henkilöitä on huomioitava turvavarusteiden komponentit (erityisesti pyrotekniset elementit) sivulla 1 olevien tietojen mukaisesti.



Työnnä litteä, muuta ainetta kuin metallia oleva esine ylhäältä sisäänviedyn ovenkahvan (1) taakse ja väännä sitä hieman ulos.



Ota kiinni ovenkahvasta (1) alta, vedä vastukseen asti ulos ja pidä siinä.

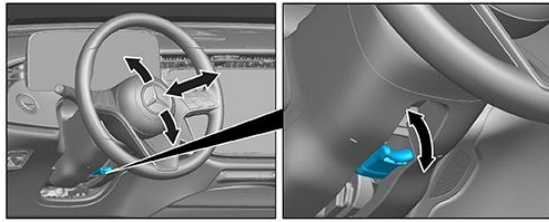

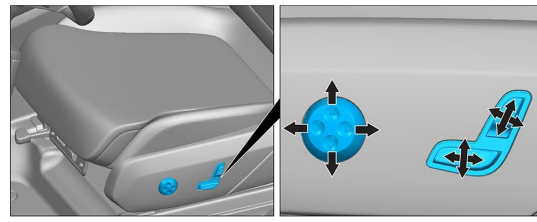

Ohjauspyörän säätö

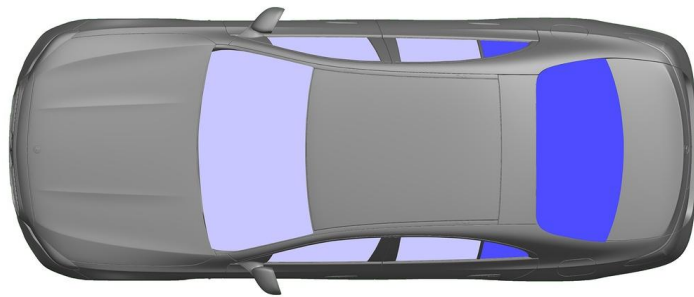

Istuimen säätö (sähköinen)



-  VSG: Laminoitu varmuuslasi
-  ESG: Karkaistu varmuuslasi

5. Ajoneuvon käyttövoima, nesteet, kiinteät aineet

	  	12V
	      	400V
	 	50L
	  	660 ± 10g



Kaikki korkeajännitejohdot on varustettu oranssilla eristyksellä.





6. Toimenpiteet tulipalon sattuessa



Käytä ajoneuvopalon sammuttamiseen suuria määriä vettä (H₂O).
Käytä litiumioniakun jäähdyttämiseen suuria määriä vettä (H₂O).



Varoitus: Akun uudelleensyttyminen



Jos korkeajänniteakusta tulee ulos jäähdytysainetta, siitä voi tulla termisen ylikuormituksen vuoksi epävakaata. Tarkasta akun lämpötila ip-lämpökamera.



7. Toimenpiteet auton joutuessa hukuksiin

Ei ole vaaraa, että korissa olisi jännite.

Ajoneuvon pelastamisen jälkeen:

1. Anna veden virrata pois sisätilasta.
2. Deaktivoi korkeajännitejärjestelmä (katso luku 3).

8. Hinaaminen / Kuljetus / Varastointi

Kuljeta ajoneuvoa vain molemmat akselit hinausautossa tai autonkuljetusautossa.



Säilytä turvallisen etäisyyden päässä muista ajoneuvoista.



Varoitus: Akun uudelleensyttyminen



9. Tärkeitä lisätietoja

Lisätietoja on kohdassa [Ohjeet henkilöautojen hinauspalveluille](#).

10. Merkkien selitykset



Luokan 1 nestemäisillä polttoaineilla toimiva sähköhybridiauto



Vaara



Jännitevaara



Syttävä



Terveydelle haitallinen



Syövyttävä



Välitön myrkyllisyys



Herkästi räjähtävä



Sammuta vedellä



Käytä IR-lämpökameraa



Konepelti



Smart-avaimen poistaminen



Air-conditioning component



Warning: low temperature