









- | | | | | |
|--|---|---|---|---|
|  Turvatyyny |  Kaasugeneraattori |  Turvavyön kiristin |  SRS-ohjainlaite |  Aktiivinen jalankulkijasuojajärjestelmä |
|  Kaasujousi / esijännitetty jousi |  Matalajänniteakku |  Bensiini polttoainesäiliö | | |

Ohje: Katso lisätietoja [pelastusohjeestamme](#).



1. Ajoneuvon tunnistaminen/ identifiointi

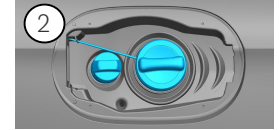
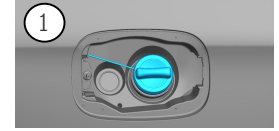

2. Ajoneuvon sammuttaminen / stabilointi

Seisontajarru

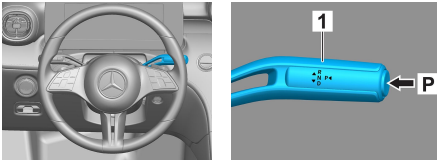

Paina kytkintä P vaihtevalitsimessa (1).
Seisontajarru aktivoidaan automaattisesti.

Seisontajarru

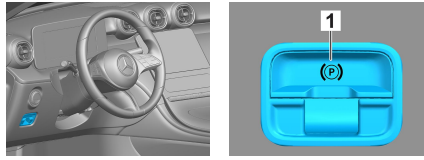

Sähköinen seisontajarru (1)

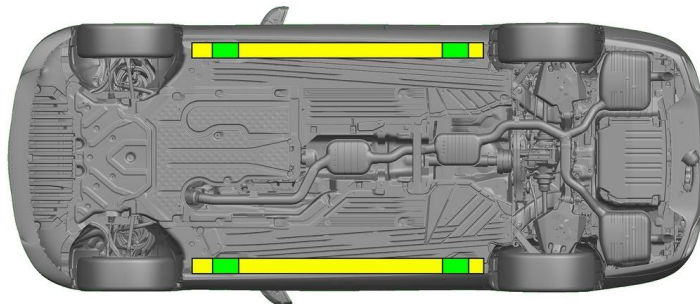

Soveltuvat nostopisteet



Soveltuvat vakautuspisteet sivulla



Kynnyksen ja pohjan lisääntyminen pelastuksen aikana (esim. tuenta hydraulikkavarusteilla) on vältettävä.

3. Ajoneuvon vaarattomaksi tekeminen

Kytke sytytysvirta pois päältä:

1. Paina START-STOP-painiketta painamatta käyttöjarrua.
2. Säilytä ajoneuvon sähköinen avain vähintään 5 metrin etäisyydellä.

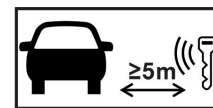

Moottorin äänien puuttuminen ei tarkoita, että ajoneuvo on kytketty pois päältä.



Uudelleenkäynnistys on mahdollista ajoneuvon käytöstäpoistamiseen asti.



12 V:n / 48 V:n akun kytkeminen irti

1. Poista 12 V:n / 48 V:n akun suojus moottoritilasta.
2. Irrota 12 V:n / 48 V:n akun miinusjohto ruuviliitännästä ja varmista tahattoman kosketuksen estämiseksi.





12/48 V:n akun kytkeminen irti

- Poista 12/48 V:n akun suojaus tavaratilasta.
- Irrota 12/48 V:n akun miinusjohto ruuviliitännästä ja varmista tahattoman kosketuksen estämiseksi.



Passiiviset turvajärjestelmät (turvatyyny ja turvavyönkieristimet) deaktivoidaan.

4. Ajoneuvon sisällä olevien pelastaminen

Vapautettaessa autossa matkustavia henkilöitä on huomioitava turvavarusteiden komponentit (erityisesti pyrotekniset elementit) sivulla 1 olevien tietojen mukaisesti.

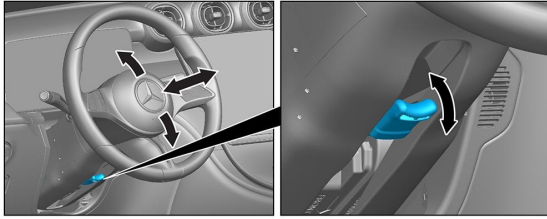

Ohjauspyörän säätö

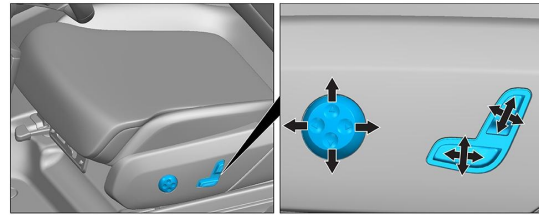

Istuimen säätö (sähköinen)

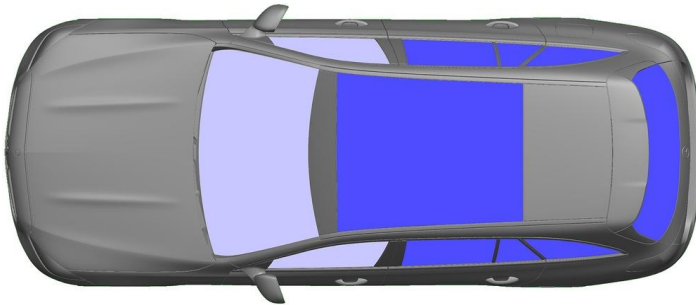

VSG: Laminoitu varmuuslasi

ESG: Karkaistu varmuuslasi

5. Ajoneuvon käyttövoima, nesteet, kiinteät aineet

		12 V/ 48 V
		66 L
		66 L
		610 ± 10 g

6. Toimenpiteet tulipalon sattuessa



Käytä ajoneuvopalon sammuttamiseen suuria määriä vettä (H₂O).

7. Toimenpiteet auton joutuessa hukuksiin

Ei ole vaaraa, että korissa olisi jännite. Ajoneuvon pelastamisen jälkeen:

- Anna veden virrata pois sisätilasta.
- Deaktivoi ajoneuvon 12 V:n / 48 V:n sähköverkko (katso luku 3).



8. Hinaaminen / Kuljetus / Varastointi

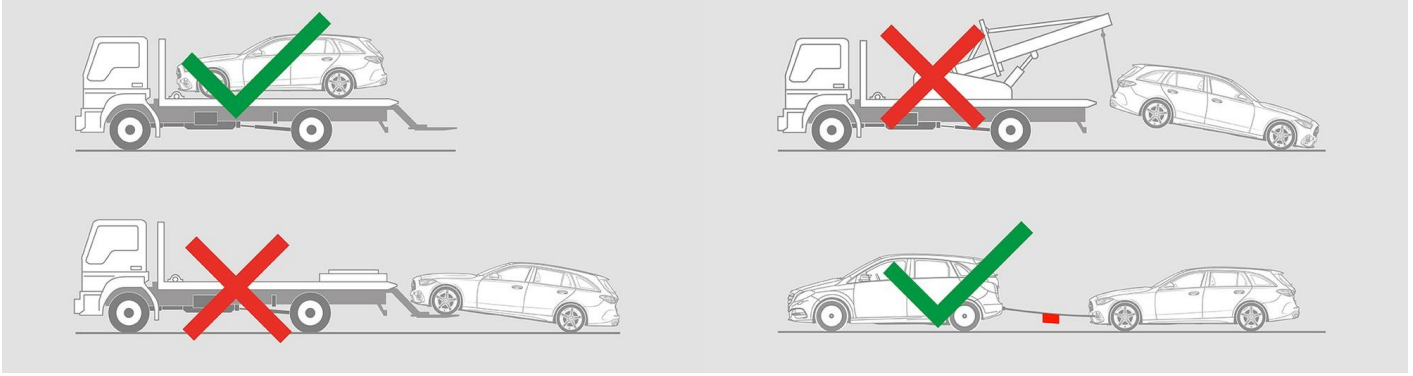

9. Tärkeitä lisätietoja

Lisätietoja on kohdassa [Ohjeet henkilöautojen hinauspalveluille](#).

10. Merkkien selitykset



Luokan 1 nestemäisiä polttoaineita käyttävä auto



Luokan 2 nestemäisiä polttoaineita käyttävä auto



Vaara



Syttyvä



Terveydelle haitallinen



Syövyttävä



Välitön myrkyllisyys



Herkästi räjähtävä



Sammuta vedellä



Sammuta kuivalla vaahdolla



Sammuta kostealla vaahdolla



Konepelti



Matkatavaratila



Smart-avaimen poistaminen



Air-conditioning component



Warning; low temperature