







① Ohjaus vasemmalla

② Ohjaus oikealla

- | | | | | |
|--|---|--|---|--|
|  Turvatyyny |  Kaasugeneraattori |  Turvavyön kiristin |  SRS-ohjainlaite |  Kaasujousi / esijännitetty jousi |
|  Matalajänniteakku |  Bensiini polttoainesäiliö | | | |

Ohje: Katso lisätietoja [pelastusohjeestamme](#).



1. Ajoneuvon tunnistaminen/ identifiointi

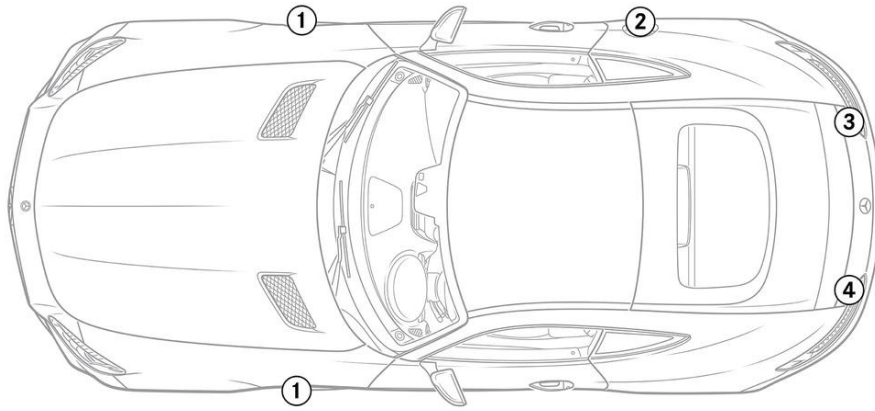

1

V8 BITURBO

2

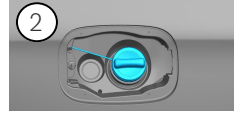

3

GT

4

