







- | | | | | |
|---|---|---|---|--|
|  Turvapadi |  Gaasigeneraator |  Turvavöö eelpinguti |  Täiendavate turvasüsteemide juhtseade |  Aktiivne jalakäijakaitse süsteem |
|  Gaasiamort / eelpingestatud vedru |  Madalpingeaku |  Diisel kütusepaak | | |

Märkus: Lisateabe saamiseks vaadake meie [päästetööde andmelehte](#).



1. Identifitseerimine / tunnustamine



2. Immobiliseerimine / stabiliseerimine / tõstmine

Parkimispidur

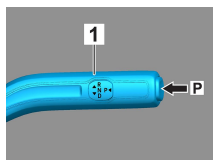
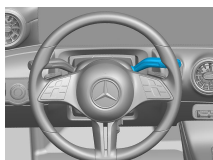

Seisupidur

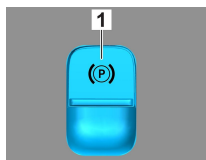

Vajutage lülitit P valitshooval (1). Parkimispidur aktiveerub automaatselt.

Elektriline seisupidur (1)

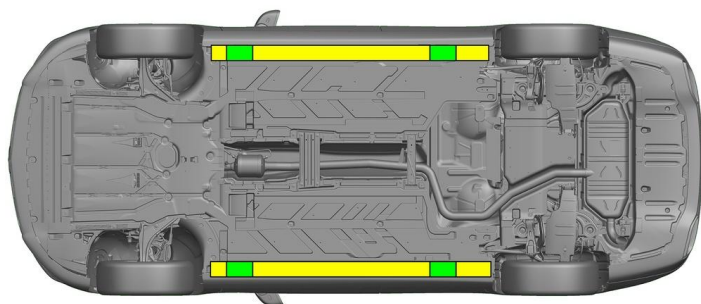

Sobiv tõstepunkt



Sobivad stabiliseerimispunktid küljel



Vältida tuleb lävede ja aluspõranda täiendavat deformeerumist päästetööde käigus (nt hüdraulikaseadmetega toetamisel).

3. Otseste ohtude kõrvaldamine / ohutusreeglid

Süüte väljalülitamine.

1. Vajutage START-STOP-nuppu ilma sõidupidurit rakendamata.
2. Hoidke elektroonilist sõidukivõtit vähemalt 5 m kaugusel.

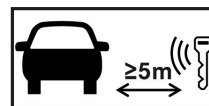

Mootorimüra puudumine ei tähenda, et sõiduk on välja lülitatud.



Taaskäivitamine on võimalik kuni sõiduki kasutusest kõrvaldamiseni.



12 V aku lahutamine

1. Eemaldage 12-voldise aku kate
2. Keerake 12-voldise aku miinuskaabel kruviühenduse juurest lahti ja kindlustage juhusliku kontakti vastu.



Passiivsed turvasüsteemid (turvapadjad ja turvavöö eelpingutid) inaktiveeritakse.



4. Juurdepääs sõitjatele

Reisijate vabastamisel tuleb jälgida turvasüsteemi komponentide (eelkõige pürotehniliste elementide) andmeid leheküljel 1.

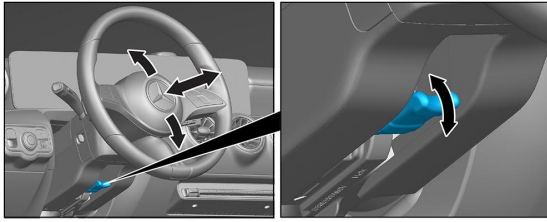

Rooli reguleerimine

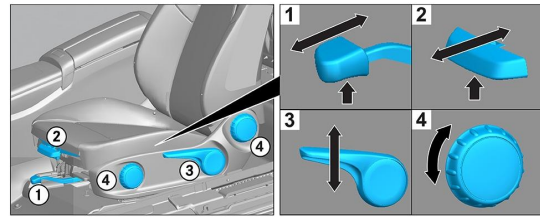

Istmeasendi reguleerimine (mehaaniline)

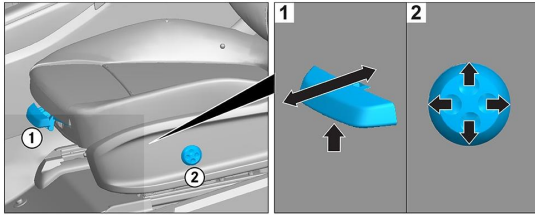

Istmeasendi reguleerimine (elektriline)

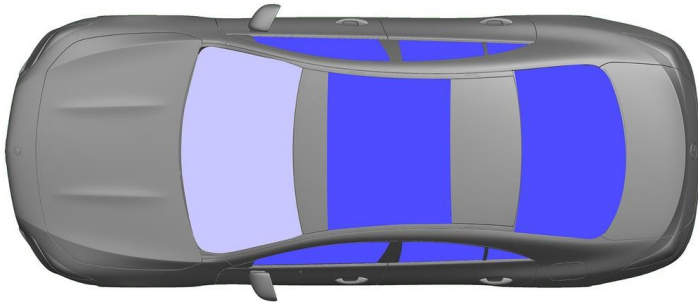

- VSG:
komposiiturvaklaas
- ESG: ühekordne turvaklaas

5. Salvestatud energia / vedelikud / gaasid / tahked ained

	 	12V
	 	43L
	 	530 ± 10g

6. Tulekahju korral



Kasutage sõiduki tulekahju kustutamiseks suurtes kogustes vett (H₂O).

7. Vee alla vajumise korral

Pinge oht kerele puudub. Pärast sõiduki päästmist

1. Laske veel salongist välja voolata.
2. Käivitage 12/48 V pardavõrgu inaktiveerimine (vt peatükki 3).



8. Pukseerimine / transportimine / hoiustamine

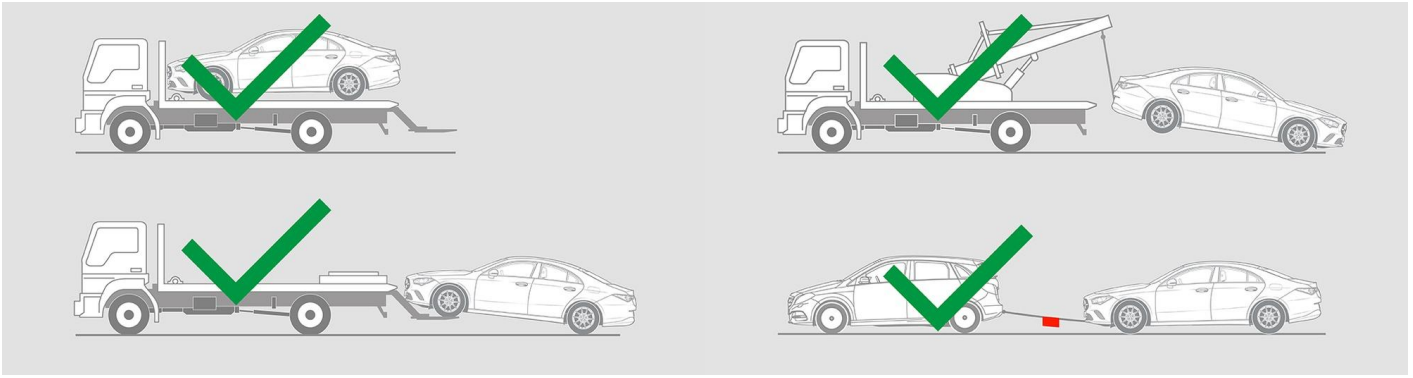

9. Tähtis lisateave

Lisateavet leiab jaotisest [Sõiduautode pukseerimisteenuste juhtnöörid](#).

10. Kasutatud piktogrammide selgitused

- | | | | |
|---------------------------------------|--------------------|--------------------------------|---------------------------------------|
| 1. grupi vedelkütusega sõiduk | Üldine hoiatussilt | Tuleohtlik | Kahjulikud inimese tervisele |
| Söövitavad | Plahvatusohtlik | Kasuta tule kustutamiseks vett | Kasuta tule kustutamiseks kuiva vahtu |
| Kasuta tule kustutamiseks märga vahtu | Kapott | Eemalda nutivõti | Kliimaseadme komponent |
| Hoiatus: madal temperatuur | | | |