







- | | | | | |
|--|---|---|---|--|
|  Turvapadi |  Gaasigeneraator |  Turvavöö eelpinguti |  Täiendavate turvasüsteemide juhtseade |  Aktiivne jalakäijakaitse süsteem |
|  Gaasiamort / eel-pingestatud vedru |  Tähelepanutsoon |  Madalpingeaku |  Diiseliütusepaak | |

Märkus: Lisateabe saamiseks vaadake meie [päästetööde andmelehte](#).



1. Identifitseerimine / tunnustamine



①

C 220d

②

4MATIC

2. Immobiliseerimine / stabiliseerimine / tõstmine

Parkimispidur



Seisupidur

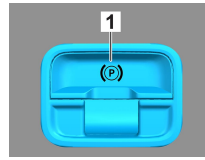

Vajutage lüliti P valitshooval (1). Parkimispidur aktiveerub automaatselt.

Elektriline seisupidur (1)

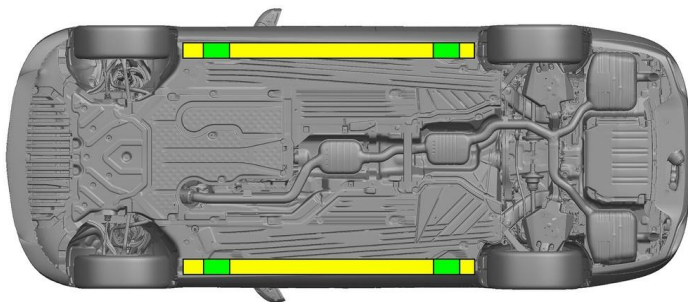

Sobiv tõstepunkt



Sobivad stabiliseerimispunktid küljel



Vältida tuleb lävede ja aluspõranda täiendavat deformeerumist päästetööde käigus (nt hüdraulikaseadmetega toetamisel).

3. Otseste ohtude kõrvaldamine / ohutusreeglid

Süüte väljalülitamine.

1. Vajutage START-STOP-nuppu ilma sõidupidurit rakendamata.
2. Hoidke elektroonilist sõidukivõtit vähemalt 5 m kaugusel.



Mootorimüra puudumine ei tähenda, et sõiduk on välja lülitatud.



Taaskäivitamine on võimalik kuni sõiduki kasutusest kõrvaldamiseni.



12/48 V aku lahutamine

1. Eemaldage mootoriruumist 12/48-voldise aku kate.
2. Keerake 12/48-voldise aku miinuskaabel kruviühenduse juurest lahti ja kindlustage juhusliku kontakti vastu.





12/48 V aku lahutamine



1. Eemaldage 12/48-voldise aku kate pakiruumi luugilt.
2. Keerake 12/48-voldise aku miinuskaabel kruviühenduse juurest lahti ja kindlustage juhusliku kontakti vastu.



Passiivsed turvasüsteemid (turvapadjad ja turvavöö eelpingutid) inaktiveeritakse.

4. Juurdepääs sõitjatele

Reisijate vabastamisel tuleb jälgida turvasüsteemi komponentide (eelkõige pürotehniliste elementide) andmeid leheküljel 1.

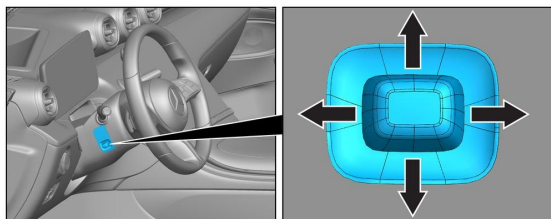

Rooli reguleerimine

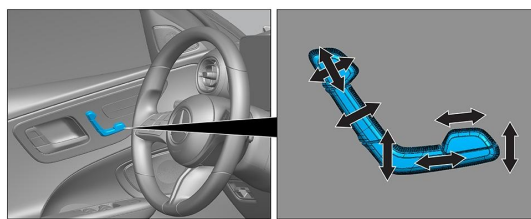

Istmeasendi reguleerimine (elektriline)

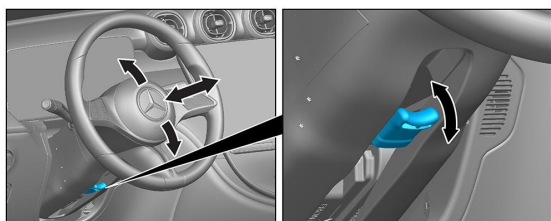

Rooli reguleerimine

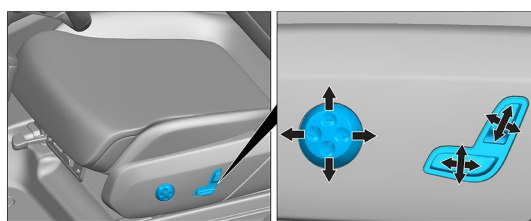

Istmeasendi reguleerimine (elektriline)

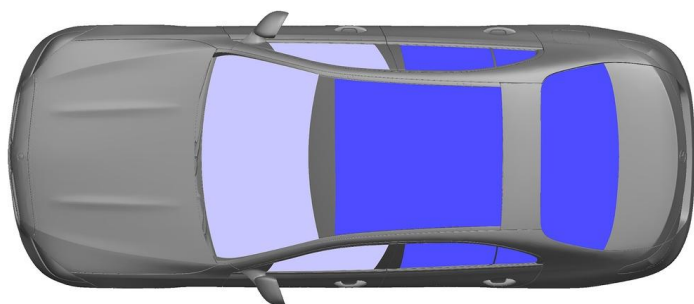

- VSG: komposiiturvaklaas
- ESG: ühekordne turvaklaas

5. Salvestatud energia / vedelikud / gaasid / tahked ained

		12 V/ 48 V
		66 L
		570 ± 10 g

6. Tulekahju korral



Kasutage sõiduki tulekahju kustutamiseks suurtes kogustes vett (H₂O).

7. Vee alla vajumise korral

Pinge oht kerele puudub. Pärast sõiduki päästmist

1. Laske veel salongist välja voolata.
2. Käivitage 12/48 V pardavõrgu inaktiveerimine (vt peatükki 3).



8. Pukseerimine / transportimine / hoiustamine

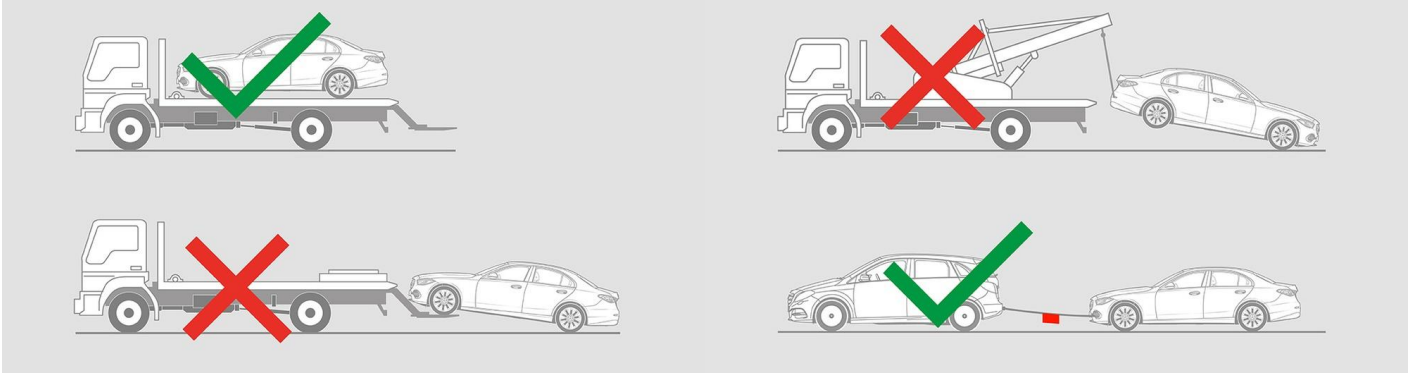

9. Tähtis lisateave

Lisateavet leiate jaotisest [Sõiduautode pukseerimisteenuste juhtnöörid](#).

10. Kasutatud piktogrammide selgitused



1. grupi vedelkütusega sõiduk



Üldine hoiatussilt



Tuleohtlik



Kahjulikud inimese tervisele



Söövitavad



Äge mürgisus



Plahvatusohtlik



Kasuta tule kustutamiseks vett



Kasuta tule kustutamiseks kuiva vahtu



Kasuta tule kustutamiseks märga vahtu



Kapott



Pakiruumi luuk



Eemalda nutivõti



Kliimaseadme komponent



Hoiatus: madal temperatuur