

- |   |                  |   |   |   |                       |   |                                       |   |                                   |
|---|------------------|---|---|---|-----------------------|---|---------------------------------------|---|-----------------------------------|
|  | Turvapadi        |  | Gaasigeneraator                               |  | Turvavöö eelpinguti   |  | Täiendavate turvasüsteemide juhtseade |  | Gaasiamort / eelpingestatud vedru |
|   | Madalpingeaku    |  | Diiseli kütusepaak                            |  | Akupakett, kõrgepinge |  | Kõrgepinge-toitejuhe                  |  | Kõrgepingekomponent               |
|   | Kaabli lõikamine |  | Madalpingeseade, mis ühendab kõrgepinge lahti |   |                       |   |                                       |   |                                   |

Märkus: Lisateabe saamiseks vaadake meie [päästetööde andmelehte](#).

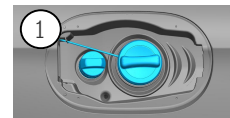

### 1. Identifitseerimine / tunnustamine



② 4MATIC

③ GLE 350de

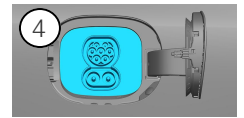

### 2. Immobiliseerimine / stabiliseerimine / tõstmine

#### Parkimispidur



#### Seisupidur

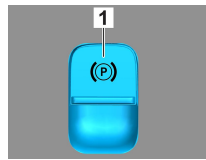
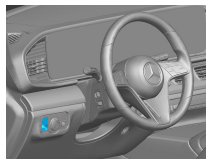

Vajutage lüliti P valitshooval (1). Parkimispidur aktiveerub automaatselt.

Elektriline seisupidur (1)

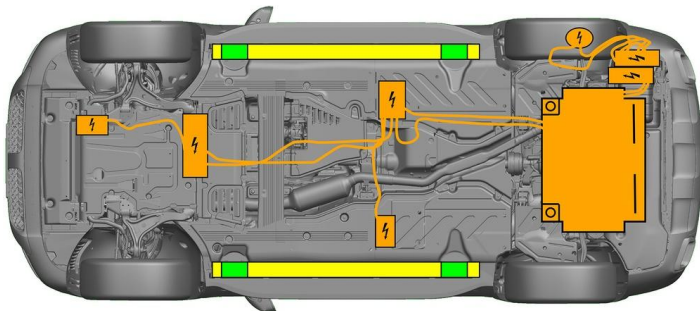

Sobiv tõstepunkt



Sobivad stabiliseerimispunktid küljel



Vältida tuleb lävede ja aluspõranda täiendavat deformeerumist päästetööde käigus (nt hüdraulikaseadmetega toetamisel).

### 3. Otseste ohtude kõrvaldamine / ohutusreeglid

#### Süüte väljalülitamine.

1. Vajutage START-STOP-nuppu ilma sõidupidurit rakendamata.
2. Hoidke elektroonilist sõidukivõtit vähemalt 5 m kaugusel.



Mootorimüra puudumine ei tähenda, et sõiduk on välja lülitatud.



Taaskäivitamine on võimalik kuni sõiduki kasutusest kõrvaldamiseni.

#### Kõrgepingesüsteemi inaktiveerimine



Õnnetuse korral, kus turvapadjad ja turvavöö eelpingutid rakenduvad, lülitub kõrgepingesüsteem automaatselt välja.





Kõigil muudel juhtudel tuleb kõrgepingesüsteem välja lülitada järgmiselt.



### Suvand 1: Kõrgepinge väljalülitusseadis

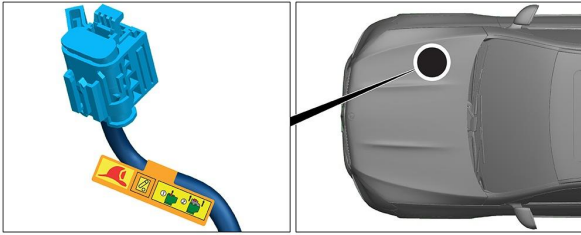

Kõrgepinge väljalülitusseadis asub mootoriruumis kõrvalistuja poolel.



- (1) Tõmmake vabastusseadist
- (2) Lükake vabastusseadis alla
- (3) Tõmmake lüliti välja



### Suvand 2: Alternatiivne kõrgepinge väljalülitusseadis

Alternatiivne kõrgepinge väljalülitusseadis asub armatuurlaual kaitsmekasti katte all, juhi poolel. See on täistatud viitava sildiga.



Eemaldage kate (1). Lõigake juhe markeeritud kohast (2) läbi.



Tagamaks, et kõrgepingevõrgus pole jääkpinget, oodake pärast väljalülitamist ca 20 sekundit.



Passiivseid turvasüsteeme, nagu turvapadjad ja turvavöö eelpingutid, varustatakse jätkuvalt 12-voldise pardavõrgu vooluga.



#### 12 V aku lahutamine

1. Eemaldage 12-voldise aku kate
2. Keerake 12-voldise aku miinuskaabel kruviühenduse juurest lahti ja kindlustage juhusliku kontakti vastu.



Passiivsed turvasüsteemid (turvapadjad ja turvavöö eelpingutid) inaktiveeritakse.



#### 4. Juurdepääs sõitjatele

Reisijate vabastamisel tuleb jälgida turvasüsteemi komponentide (eelkõige pürotehniliste elementide) andmeid leheküljel 1.

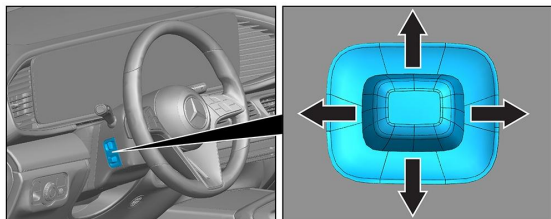

Rooli reguleerimine

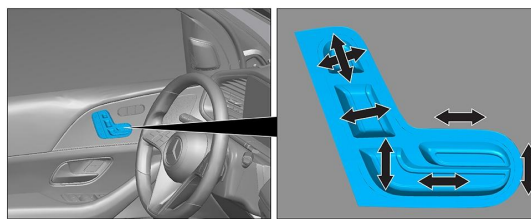

Istmeasendi reguleerimine (elektriline)

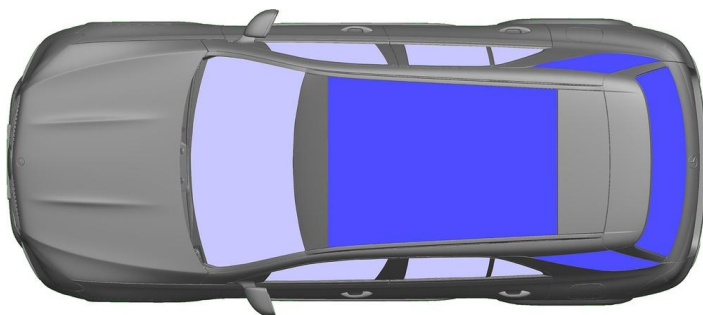

- VSG: komposiiturvaklaas
- ESG: ühekordne turvaklaas

#### 5. Salvestatud energia / vedelikud / gaasid / tahked ained

		12V
		400V
		65L
		700 ± 10g



Kõik kõrgepingejuhtmed on varustatud oranži värvi isolatsiooniga.

#### 6. Tulekahju korral



Kasutage sõiduki tulekahju kustutamiseks suures koguses vett (H<sub>2</sub>O).  
Kasutage liitiumioonaku jahutamiseks suuremates kogustes vett (H<sub>2</sub>O).



Hoiatus! Aku taassütitimine



Kui kõrgepingeakust lekib jahutusvedelikku, võib see termilise ülekoormuse tõttu muutuda ebastabiilseks. Kontrollige aku temperatuuri infrapunatermokaameraga.



#### 7. Vee alla vajumise korral

Pinge oht kerele puudub.

Pärast sõiduki päästmist

1. Laske veel salongist välja voolata.
2. Käivitage kõrgepingesüsteemi inaktiveerimine (vt peatükki 3).



## 8. Pukseerimine / transportimine / hoiustamine

Transportige sõidukit ainult koos mõlema teljega puksiirauto või autotranspordi abil.

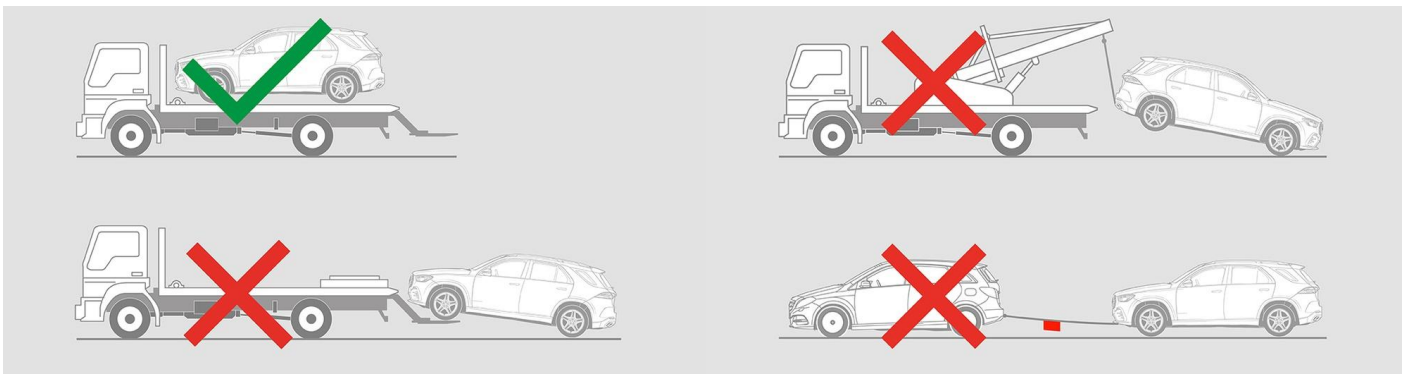

Hoidke teiste sõidukitega ohutut vahemaad.



Hoiatus! Aku taassütitamine



## 9. Tähtis lisateave

Lisateavet leiате jaotisest [Sõiduautode pukseerimisteenuste juhtnõõrid](#).

## 10. Kasutatud piktogrammide selgitused



1. grupi vedelkütusega töötav hübriidelektri-sõiduk



Üldine hoiatussilt



Hoiatus. Elekter



Tuleohtlik



Kahjulikud inimese tervisele



Söövitavad



Äge mürgisus



Plahvatusohtlik



Kasuta tule kustutamiseks vett



Kasutage infrapuna-soojuskaamerat



Kapott



Eemalda nutivõti



Kliimaseadme komponent



Hoiatus: madal temperatuur