







-  Airbag
-  Gas generator
-  Seat belt pretensioner
-  SRS control unit
-  Gas strut / Pre-loaded spring
-  Low-voltage battery
-  Diesel Fuel tank

Note: Please see our [emergency response guide](#) for more information



1. Identification / recognition



2
G 450 d

2. Immobilisation / stabilisation / lifting

Parking brake

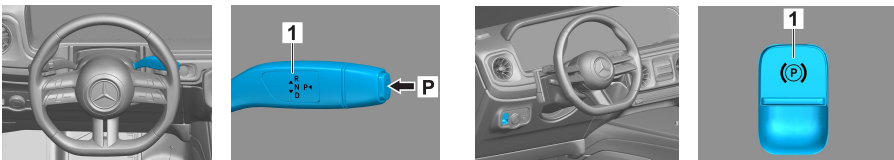

Press the P switch on the gear selector (1). The parking brake is automatically activated. Electric parking brake (1)

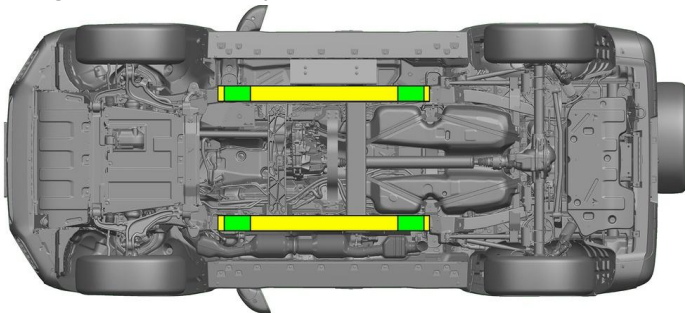

Suitable lifting points
 Suitable stabilisation points on the side

Additional deformation of the door sills and the underbody (e.g. through support with hydraulic equipment) must be avoided during the rescue.

3. Disable direct hazards / safety regulations

Switch off the ignition:

- 1. Press the START/STOP button without actuating the service brake.
- 2. Keep the electronic vehicle key at a distance of at least 5 m.

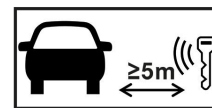

The absence of engine noise does not mean that the vehicle is switched off.

A restart is possible until the vehicle is switched off.



Disconnecting the 48 V battery



- 1. Remove floor panel in boot (unscrew the 4 tie-down eyes), then remove various trims (on C-, D-pillar, beltline, etc.), and the side wall trim to gain access to the 48-V battery.
- 2. Disconnect the negative cable of the 48-volt battery at the screw connection and secure it against unintentional contact.



Disconnecting the 12 V battery



1. Remove floor panel in boot (unscrew the 4 tie-down eyes) to gain access to the 12-V battery.
2. Disconnect the negative cable of the 12-volt battery at the screw connection and secure it against unintentional contact.



The passive safety systems (airbags and seat belt pretensioners) are deactivated.

4. Access to the occupants

When freeing the occupants, areas of the bodywork which are made from high-strength steels and the components of the restraint systems (in particular pyrotechnic elements) must be taken into consideration in accordance with the information on page 1.

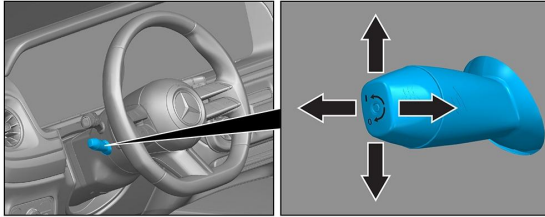

Steering wheel adjustment

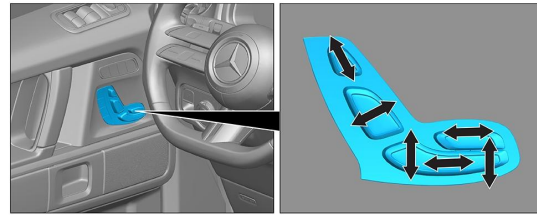

Seat adjustment (electric)



- VSG: Laminated safety glass
- ESG: Tempered glass

5. Stored energy / liquids / gases / solids

		12/48V
		100L
		630 ± 10g

6. In case of fire



Use large volumes of water (H₂O) to extinguish a vehicle fire.

7. In case of submersion

There is no risk of voltage in the bodywork. After recovery of the vehicle:

1. Allow the water to drain out of the interior.
2. Commence deactivation of the 12 V/48 V electrical system (see Section 3).





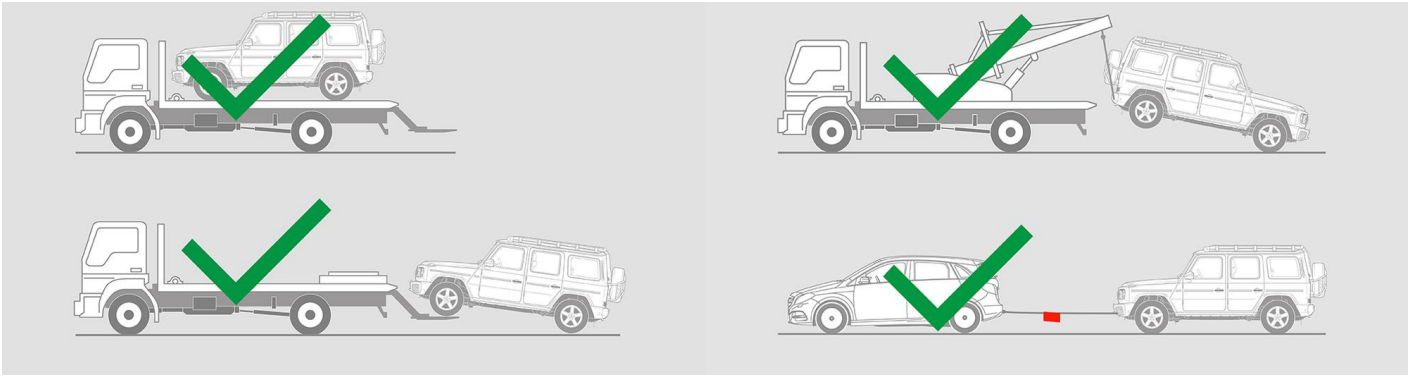









8. Towing / transportation / storage



9. Important additional information

You can find more information in the [Guidelines for car towing services](#).

10. Explanation of pictograms used

-  Vehicle on fuel of liquid group 1
-  General warning sign
-  Flammable
-  Hazardous to the human health
-  Corrosives
-  Explosive
-  Use water to extinguish the fire
-  Use dry foam to extinguish the fire
-  Use wet foam to extinguish the fire
-  Boot
-  Remove smart key
-  Air-conditioning component
-  Warning; low temperature