







① Left-hand drive

② Right-hand drive

-  Airbag
-  Gas generator
-  Seat belt pretensioner
-  SRS control unit
-  Active pedestrian protection system
-  Gas strut / Pre-loaded spring
-  Low-voltage battery
-  Petrol fuel tank
-  Battery pack, High-voltage
-  High voltage power cable
-  High voltage component
-  Cable cut
-  Low voltage device that disconnects high voltage

Note: Please see our [emergency response guide](#) for more information



1. Identification / recognition

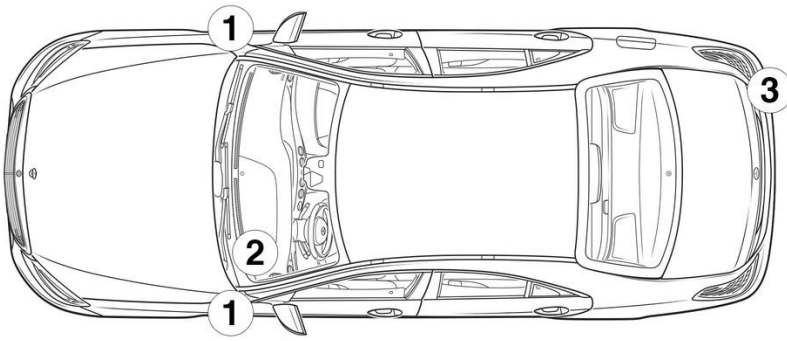

①

EQ POWER

②

整车型号 S 560 e L (222173)

③



2. Immobilisation / stabilisation / lifting

Parking brake



Press the P switch on the gear selector (1). The parking brake is automatically activated. Electric parking brake (1)

3. Disable direct hazards / safety regulations

Switch off the ignition:

1. Press the START/STOP button without actuating the service brake.
2. Keep the electronic vehicle key at a distance of at least 5 m.



The absence of engine noise does not mean that the vehicle is switched off.



A restart is possible until the vehicle is switched off.

Deactivation of the high-voltage system



The high-voltage system is automatically switched off in the event of accidents in which the airbags and seat belt pretensioners trigger.





In all other cases, the high-voltage system should be deactivated as follows:

Option 1: High-voltage disconnect

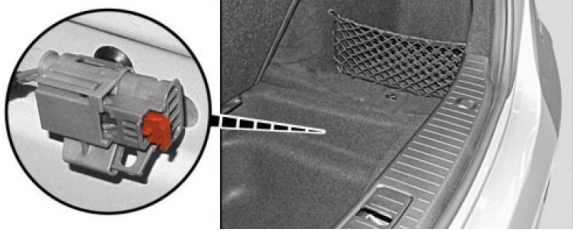

The high-voltage disconnect device is located on the right at the rear under the cover of the trunk recess. The recess lining is pulled out of the trunk by the tab below the trunk sill in the center of the vehicle.

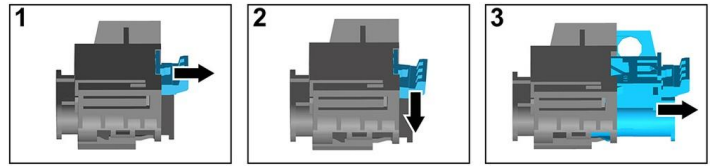

- (1) Pull the release
- (2) Push the release down
- (3) Pull out the switch

Option 2: Alternative high-voltage disconnect



The alternative high-voltage disconnect is located under the cover of the fuse box in the cockpit on the driver's side. It is indicated with a sign.

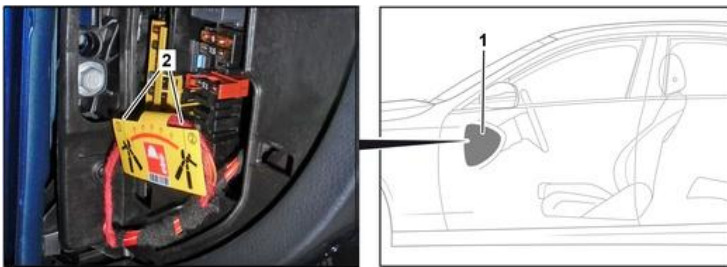

Remove the cover (1). Cut the cable at the marked point (2).



In order to ensure that there is no longer any residual voltage in the high-voltage system, wait approx. 20 seconds after switching it off.



The passive safety systems such as airbags and seat belt pretensioners will continue to be supplied with power by the 12-volt electrical system.



Disconnecting the 12 V battery



- 1. Remove the cover from the 12-volt battery in the boot.
- 2. Disconnect the negative cable of the 12-volt battery at the screw connection and secure it against unintentional contact.



8. Towing / transportation / storage

Only transport the vehicle with both axles on a tow truck or car transporter.

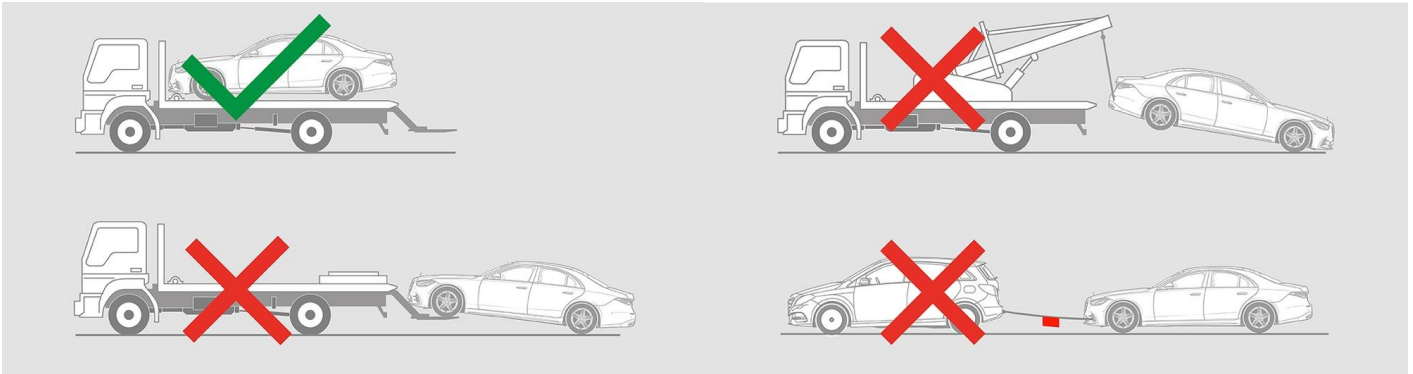

Maintain a safe distance from other vehicles.



Warning: Battery re-ignition

