









- | | | | | |
|--|--|--|---|--|
|  Airbag |  Seat belt pretensioner |  SRS control unit |  Gas strut / Pre-loaded spring |  High strength zone |
|  Low-voltage battery |  Battery pack, High-voltage |  High voltage component |  High voltage device that disconnects high voltage | |

Note: Please see our [emergency response guide](#) for more information



1. Identification / recognition

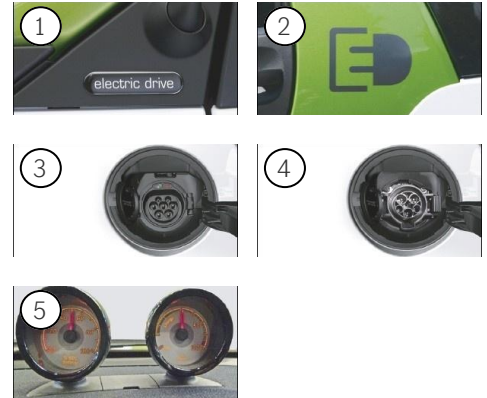
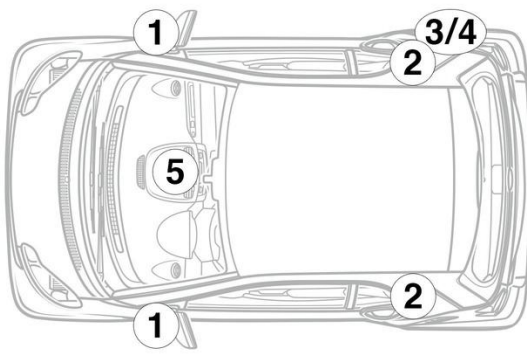

3. Disable direct hazards / safety regulations

Deactivation of the high-voltage system

In all other cases, the high-voltage system should be deactivated as follows:

High-voltage disconnect



The high-voltage disconnect device is located on the underside of the high-voltage battery on the left at the rear.

Remove cover (1) / Open lock (2) on connector (3) / Unplug connector (3) from high-voltage battery



In order to ensure that there is no longer any residual voltage in the high-voltage system, wait approx. 20 seconds after switching it off.



The passive safety systems such as airbags and seat belt pretensioners will continue to be supplied with power by the 12-volt electrical system.



Disconnecting the 12 V battery

1. Remove the cover from the 12-volt battery.
2. Disconnect the negative cable of the 12-volt battery at the screw connection and secure it against unintentional contact.