







① Linkslenker

② Rechtslenker

- | | | | | |
|--|--|--|---|--|
|  Airbag |  Gasgenerator |  Gurtstraffer |  SRS Steuergerät |  Gasdruckdämpfer / vorgespannte Feder |
|  Niedervolt-Batterie |  Benzin Treibstoff-tank | | | |

Hinweis: Weiterführende Informationen entnehmen Sie bitte unserem [Rettungsleitfaden](#).



1. Identifizierung / Erkennung

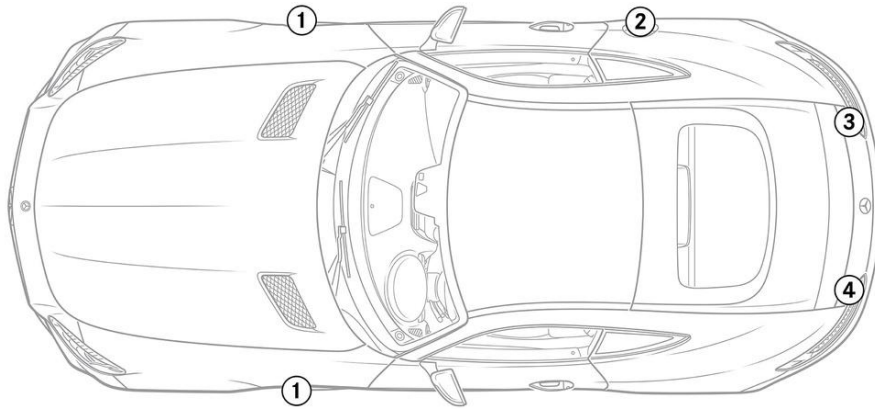

1

V8 BITURBO

2

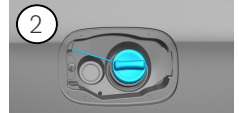

3

GT

4

