

① Gasflaske (Camping Gaz, 2,75 kg)

- | | | | | |
|--|---|---|--|---|
|  Airbag |  Gaskgenerator |  Forspænder til sikkerhedssele |  SRS kontrolenhed |  Gastryksdæmper/forspændt fjeder |
|  Lavspændingsbatteri |  Diesel brændstofftank |  Benzintank | | |

Bemærkning: For yderligere oplysninger henvises til vores [redningsvejledning](#).



1. Identifikation / genkendelse

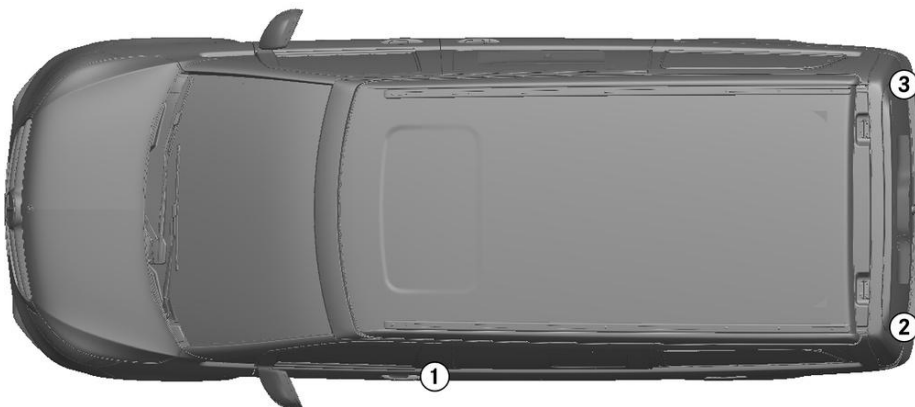

②

MARCO POLO

③

4MATIC

2. Immobilisering / Stablisering / Løft

Parkeringsbremse

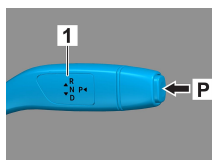
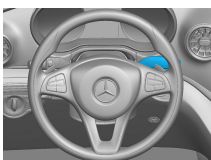

Håndbremse

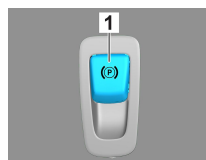

Tryk på kontakten P på gearvælgeren (1). Parke-
ringsbremsen aktiveres automatisk.

Elektrisk håndbremse (1)

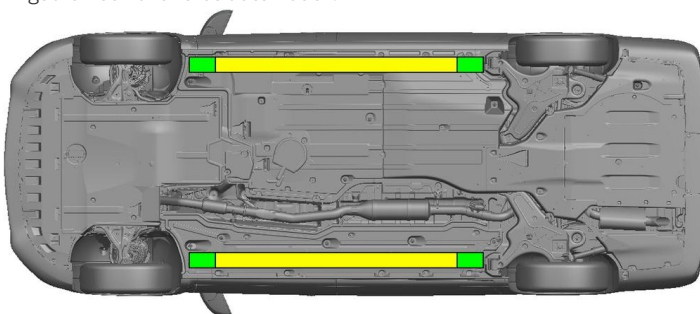

Egnede løftepunkter



Egnede stabiliseringspunkter på siden



Yderligere deformering af karme og undervogn under bjærgningen (f.eks. ved afstivning med hydraulisk udstyr) skal undgås.

3. Deaktivering særlige farer / sikkerhedsforskrifter

Slå tændingen fra:

1. Tryk på START-STOP-knappen uden at aktivere driftsbremsen.
2. Hold den elektroniske køretøjsnøgle i en afstand på mindst 5 m.

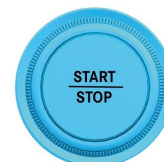
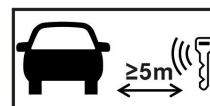

Fraværet af motorlyde betyder ikke, at køretøjet er slukket.



En genstart er mulig, indtil køretøjet tages ud af drift.



Afbryd 12 V-batteriet

1. Fjern dækslet til 12-voltsbatterierne.
2. Løsn minuskablet på 12-voltsbatteriet ved skrueforbindelsen, og sikr det mod utilsigtet kontakt.



De passive sikkerhedssystemer (airbags og forspændere til sikkerhedssele) deaktiveres.



4. Adgangveje til tilskadekommande

Ved frigørelse af personerne i bilen skal der tages hensyn til komponenterne i sikkerhedssystemerne (især pyrotekniske elementer) i overensstemmelse med angivelserne på side 1.



Ratindstilling



Sædeindstilling (mekanisk)

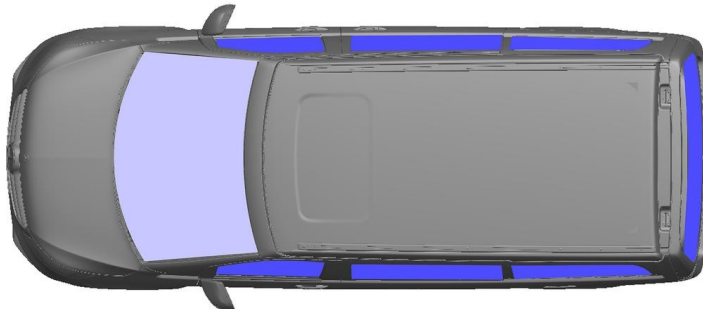

VSG: lamineret
sikkerhedsglas
ESG: hærdet glas

5. Oplagret energi / væsker / gasser / faste stoffer

		12 V
		57 L
		900 ± 10 g

6. I tilfælde af brand



Brug store mængder vand (H₂O), når en køretøjsbrand skal slukkes.

7. I vand

Der er ingen fare ved, at der er spænding på karrosseriet. Efter bjærgning af køretøjet:

1. Lad vandet løbe ud af kabinen.
2. Påbegynd deaktivering af 12-/48-voltsledningsnettet (se kapitel 3).

8. Bugsering / transport / opbevaring

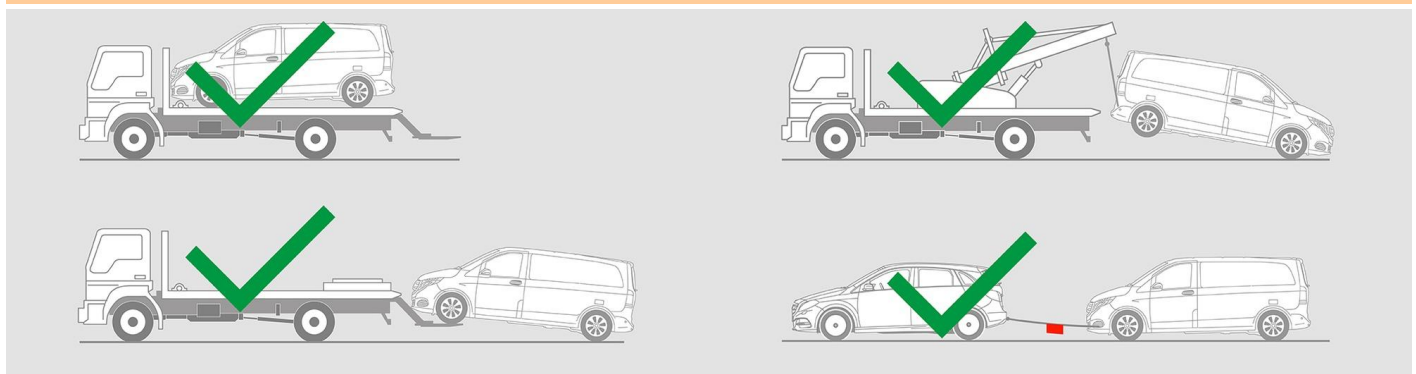



9. Vigtige ekstra oplysninger

Yderligere oplysninger findes i [Vejledning for bjærgningsfirmaer, personvogne](#).

10. Piktogram information

	Køretøj på brændstof i klasse 1		Generelt advarsskilt		Brandfarligt		Farligt for menneskers sundhed
	Ætsende		Eksplosiv		Brug vand til at slukke ilden		Brug tørt skum til at slukke ilden
	Brug vådt skum til at slukke ilden		Fjern smart nøgle		Klimaanlæg		Advarsel; lav temperatur