

-  Airbag
-  Gasgenerator
-  Forspænder til sikkerhedssele
-  SRS kontrolenhed
-  Gastryksdæmper/forspændt fjeder
-  Lavspændingsbatteri
-  Benzinae brændstoftank

Bemærkning: For yderligere oplysninger henvises til vores [redningsvejledning](#).

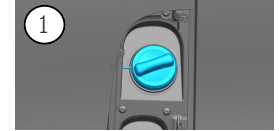

1. Identifikation / genkendelse



2. Immobilisering / Stablisering / Løft

Parkeringsbremse

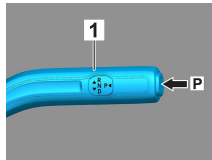

Håndbremse

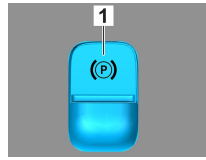

Sæt gearvælger (1) i position P. Parkeringsbremsen aktiveres automatisk.

Elektrisk håndbremse (1)

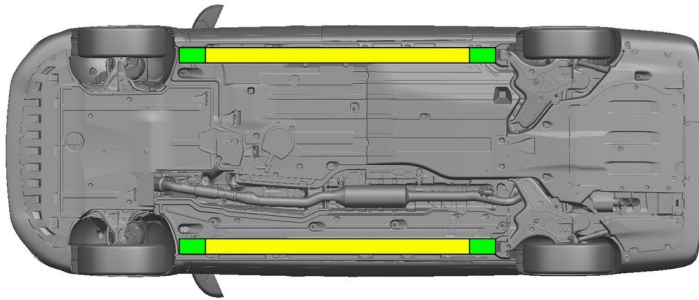

Egnede løftepunkter



Egnede stabiliseringspunkter på siden



Yderligere deformering af karme og undervogn under bjærgningen (f.eks. ved afstivning med hydraulisk udstyr) skal undgås.

3. Deaktivering særlige farer / sikkerhedsforskrifter

Slå tændingen fra:

1. Tryk på START-STOP-knappen uden at aktivere driftsbremsen.
2. Hold den elektroniske køretøjsnøgle i en afstand på mindst 5 m.

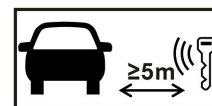

Fraværet af motorlyde betyder ikke, at køretøjet er slukket.



En genstart er mulig, indtil køretøjet tages ud af drift.



Afbryd 48 V-batteriet

1. Fjern dækslet til 48-voltsbatterierne.
2. Løsn minuskablet på 48-voltsbatteriet ved skrueforbindelsen, og sikr det mod utilsigtet kontakt.

**Afbryd 12 V-batteriet**

1. Fjern dækslet til 12-voltsbatterierne.
2. Løsn minuskablet på 12-voltsbatteriet ved skrueforbindelsen, og sikr det mod utilsigtet kontakt.



De passive sikkerhedssystemer (airbags og forspændere til sikkerhedssele) deaktiveres.

4. Adgangveje til tilskadekommande

Ved frigørelse af personerne i bilen skal der tages hensyn til komponenterne i sikkerhedssystemerne (især pyrotekniske elementer) i overensstemmelse med angivelserne på side 1.

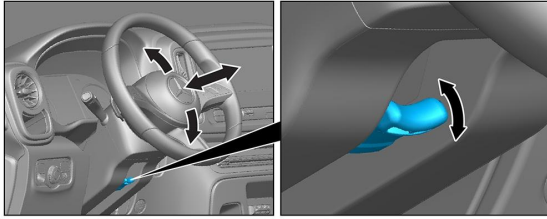

Ratindstilling

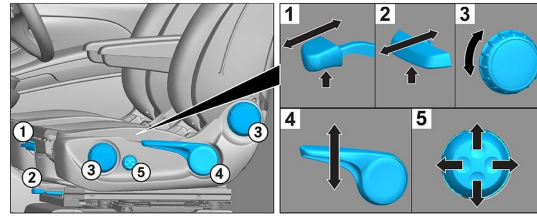

Sædeindstilling (mekanisk)

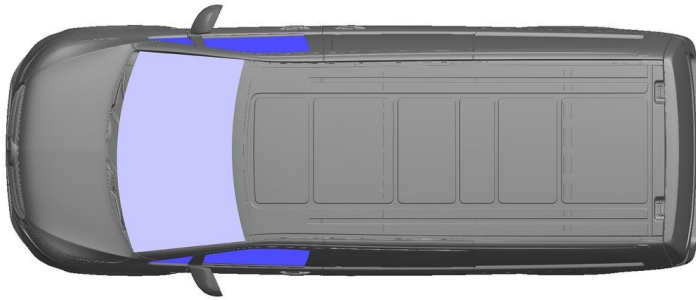

- VSG: lamineret sikkerhedsglas
- ESG: hærdet glas

5. Oplagret energi / væsker / gasser / faste stoffer

						12 V/ 48 V
						70 L
						600 ± 10 g

6. I tilfælde af brand

Brug store mængder vand (H₂O), når en køretøjsbrand skal slukkes.

7. I vand

Der er ingen fare ved, at der er spænding på karrosseriet. Efter bjærgning af køretøjet:

1. Lad vandet løbe ud af kabinen.
2. Påbegynd deaktivering af 12-/48-voltsledningsnettet (se kapitel 3).



8. Bugsering / transport / opbevaring

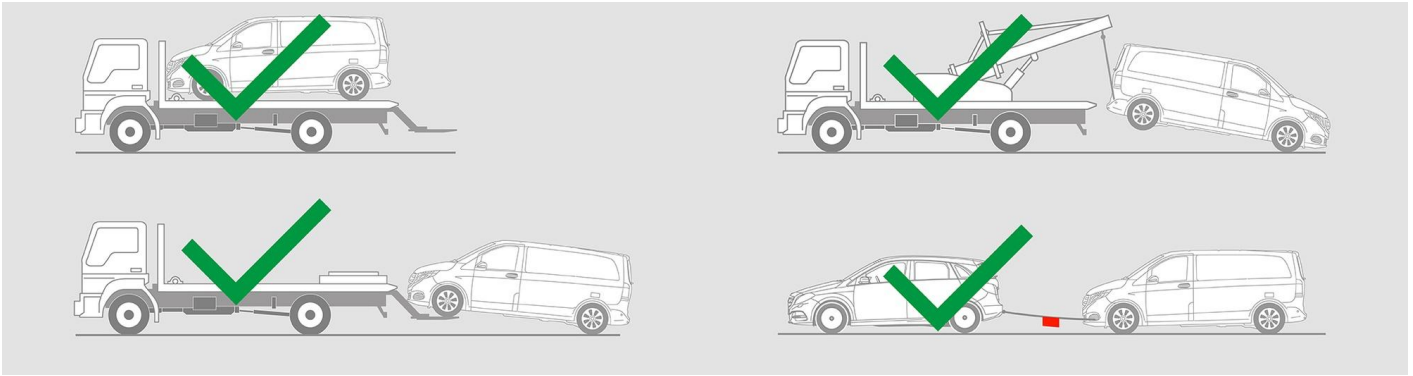

9. Vigtige ekstra oplysninger

Yderligere oplysninger findes i [Vejledning for bjærgningsfirmaer, personvogne](#).

10. Piktogram information

-  Køretøj på brændstof i klasse 2
-  Generelt advarsskilt
-  Brandfarligt
-  Farligt for menneskers sundhed
-  Ætsende
-  Akut toksicitet
-  Eksplosiv
-  Brug tørt skum til at slukke ilden
-  Brug vådt skum til at slukke ilden
-  Fjern smart nøgle
-  Klima anlæg
-  Advarsel; lav temperatur