

-  Airbag
-  Gasgenerator
-  Forspænder til sikkerhedssele
-  SRS kontrolenhed
-  Gastryksdæmper/forspændt fjeder
-  Lavspændingsbatteri
-  Benzinae brændstofftank
-  Batteripakke, højspænding
-  Højspændingskabel
-  Højspændingskomponent
-  Kabelskæring
-  Lavspændingsenhed, der afbryder højspænding

Bemærkning: For yderligere oplysninger henvises til vores [redningsvejledning](#).

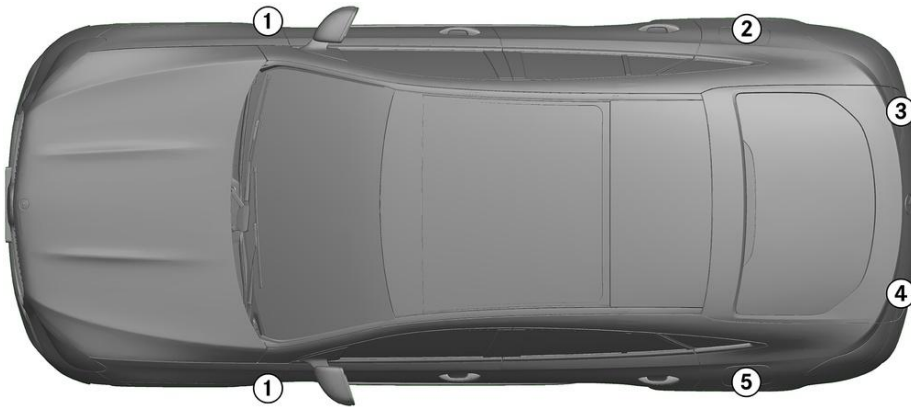

### 1. Identifikation / genkendelse



### 2. Immobilisering / Stabilisering / Løft

#### Parkeringsbremse

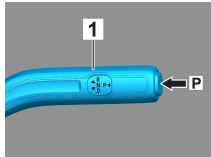

#### Håndbremse

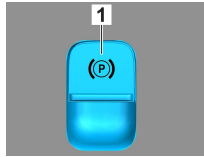
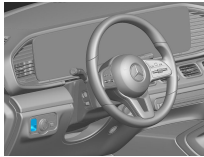

Tryk på kontakten P på gearvælgeren (1). Parke-  
ringsbremsen aktiveres automatisk.

Elektrisk håndbremse (1)

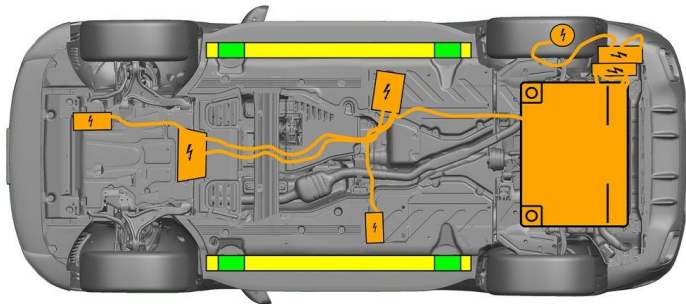

- Egnede løftepunkter
- Egnede stabiliseringspunkter på siden
- Højvoltsbatteri



Yderligere deformation af karme og undervogn under bjærgningen (f.eks. ved afstivning med hydraulisk udstyr) skal undgås.

### 3. Deaktivering særlige farer / sikkerhedsforskrifter

#### Slå tændingen fra:

1. Tryk på START-STOP-knappen uden at aktivere driftsbremsen.
2. Hold den elektroniske køretøjsnøgle i en afstand på mindst 5 m.

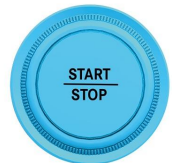
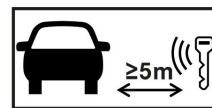

Fraværet af motorlyde betyder ikke, at køretøjet er slukket.



En genstart er mulig, indtil køretøjet tages ud af drift.

#### Deaktivering af højvoltssystemet



I tilfælde af ulykker, hvor airbags og forspændere til sikkerhedssele udløses, slås højvoltssystemet automatisk fra.





I alle andre tilfælde skal højvoltage systemet deaktiveres på følgende måde:

### Mulighed 1: Højvoltsafbryder

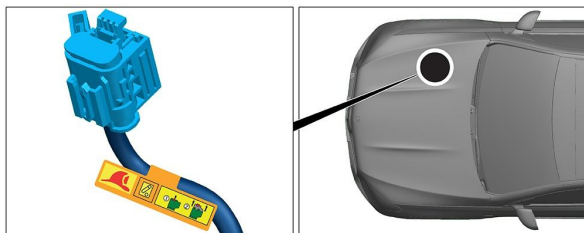

Højvoltsafbryderen sidder i motorrummet i passagersiden.

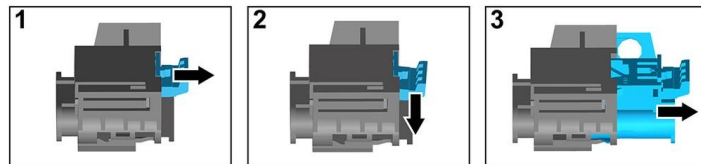

- (1) Træk i grebet til oplåsning
- (2) Tryk grebet til oplåsning nedad
- (3) Træk kontakten ud



### Mulighed 2: Alternativ højvoltsafbryder

Den alternative højvoltsafbryder sidder under dækslet til sikringsboksen i cockpittet i førersiden. Den er afmærket.

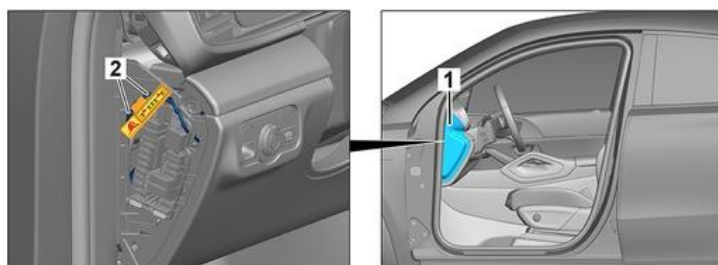

Fjern dækslet (1). Skær ledningen over ved det markerede punkt (2).



For at sikre, at der ikke er restspænding i højspændingsnettet, skal du vente cirka 20 sekunder efter afbrydelsen.



De passive sikkerhedssystemer såsom airbags og forspændere til sikkerhedssele forsynes fortsat med strøm fra 12-voltsledningsnettet.



### Afbryd 12 V-batteriet

1. Fjern dækslet til 12-voltsbatterierne.
2. Løsn minuskablet på 12-voltsbatteriet ved skrueforbindelsen, og sikr det mod utilsigtet kontakt.



De passive sikkerhedssystemer (airbags og forspændere til sikkerhedssele) deaktiveres.



#### 4. Adgangveje til tilskadekommande

Ved frigørelse af personer i bilen skal der tages hensyn til komponenterne i sikkerhedssystemerne (især pyrotekniske elementer) i overensstemmelse med angivelserne på side 1.

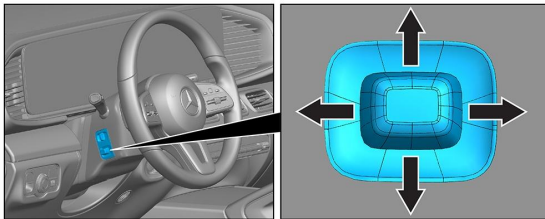

Ratindstilling

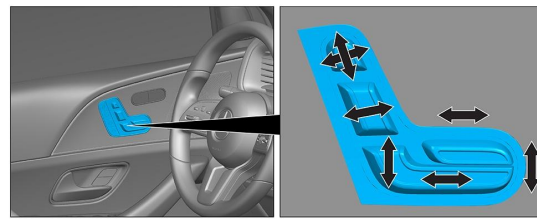

Sædeindstilling (elektrisk)

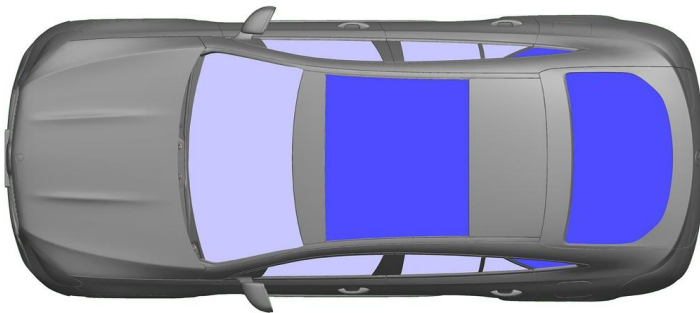

- VSG: lamineret sikkerhedsglas
- ESG: hærdet glas

#### 5. Oplagret energi / væsker / gasser / faste stoffer

|  |  |            |
|--|--|------------|
|  |  | 12 V       |
|  |  | 400 V      |
|  |  | 65 L       |
|  |  | 700 ± 10 g |

Alle højvoltsledninger er forsynet med en orangefarvet isolering.

#### 6. I tilfælde af brand

Brug store mængder vand (H<sub>2</sub>O), når en køretøjsbrand skal slukkes.  
 Brug store mængder vand (H<sub>2</sub>O) til at afkøle li-ion-batteriet.

Advarsel: Genantændelse af batteriet

Hvis kølemiddel lækker fra højvoltbatteriet, kan det blive ustabil på grund af termisk overbelastning. Kontrollér batteriets temperatur med et IR-varmefølsomt kamera.

#### 7. I vand

Der er ingen fare ved, at der er spænding på karrosseriet.  
 Efter bjærgning af køretøjet:  
 1. Lad vandet løbe ud af kabinen.  
 2. Påbegynd deaktivering af højvoltssystemet (se kapitel 3).



### 8. Bugsering / transport / opbevaring

Transportér kun køretøjet med begge hjulsæt på et bugseringskøretøj eller en autotransporter.

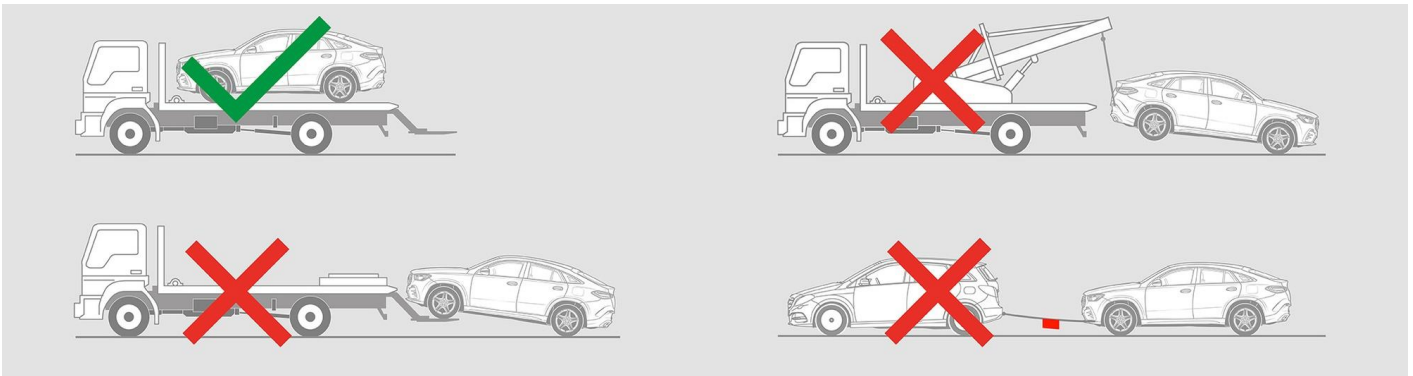















Opbevaring i sikker afstand af andre køretøjer.

 Advarsel: Genantændelse af batteriet 

### 9. Vigtige ekstra oplysninger

Yderligere oplysninger findes i [Vejledning for bjærgningsfirmaer, personvogne](#).

### 10. Piktogram information

- |   |   |  |   |
|---|---|--|---|
|  Hybrid elektrisk køretøj på brændstof i klasse 2 |  Generelt advarselsskilt       |  Advarsel, elektricitet |  Brandfarligt      |
|  Farligt for menneskers sundhed                  |  Ætsende                       |  Akut toksicitet        |  Eksplosiv         |
|  Brug vand til at slukke ilden                   |  Brug termisk infrarødt kamera |  Motorhjelm             |  Fjern smart nøgle |
|  Klimaanlæg                                       |  Advarsel; lav temperatur      |  |   |